



USERS GUIDE

Connect Tech Inc.

Embedded Computing Experts

www.connecttech.com

COM Express® Type 7 Carrier Board

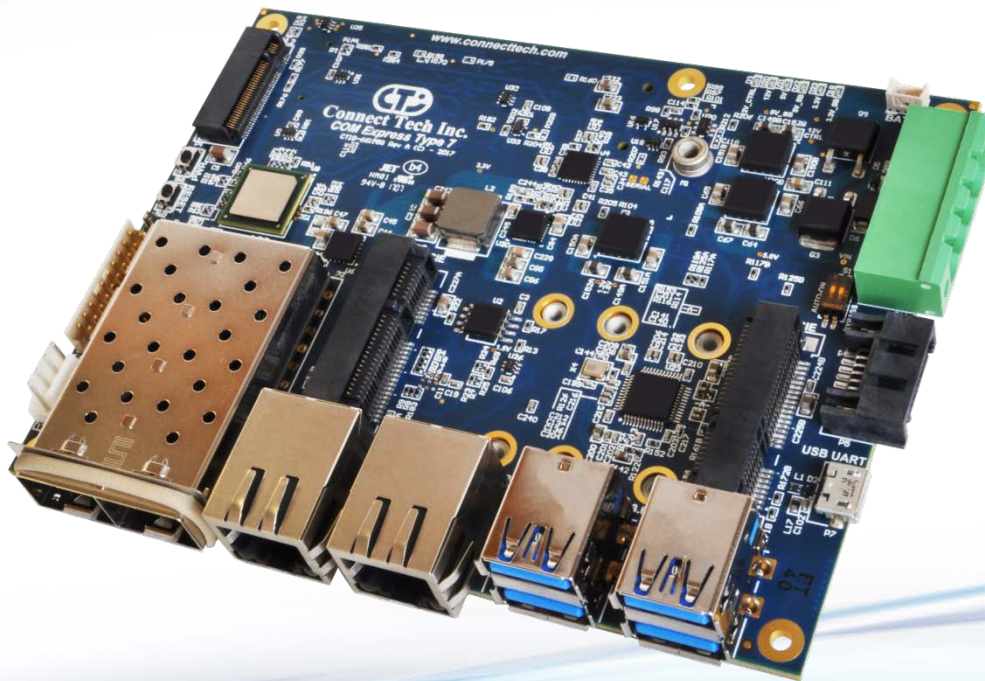

Connect Tech Inc.

42 Arrow Road
Guelph, Ontario
N1K 1S6

www.connecttech.com

Tel: 519-836-1291

Toll: 800-426-8979 (North America only)

Fax: 519-836-4878

Email: sales@connecttech.com

support@connecttech.com

Table of Contents

Table of Contents	2
Preface	3
Disclaimer.....	3
Customer Support Overview.....	3
Contact Information.....	3
Limited Product Warranty.....	4
Copyright Notice.....	4
Trademark Acknowledgment.....	4
ESD Warning.....	5
Revision History	5
Introduction	6
Product Features and Specifications.....	6
Part Numbers / Ordering Information.....	6
Product Overview	7
Block Diagram.....	7
Connector Locations.....	8
Top View.....	8
Bottom View.....	9
Jumper and Connector Summary.....	9
Detailed Feature Description	10
COM Express Module Connector.....	10
COM Express Interface Usage and Allocation.....	10
Network.....	11
USB.....	11
Bus Expansion.....	12
Storage.....	12
Serial and GPIO.....	13
Input Power, RTC Battery and Fan.....	14
RTC Battery.....	15
Typical Hardware Installation for +12V power input	16
Cables and Accessories	17
Available from Connect Tech.....	17
Useful Third Party Hardware and Accessories.....	17
Assembly Hardware.....	17
Cables and Modules.....	17

Preface

Disclaimer

The information contained within this user's guide, including but not limited to any product specification, is subject to change without notice.

Connect Tech assumes no liability for any damages incurred directly or indirectly from any technical or typographical errors or omissions contained herein or for discrepancies between the product and the user's guide.

Customer Support Overview

If you experience difficulties after reading the manual and/or using the product, contact the Connect Tech reseller from which you purchased the product. In most cases the reseller can help you with product installation and difficulties.

In the event that the reseller is unable to resolve your problem, our highly qualified support staff can assist you. Our support section is available 24 hours a day, 7 days a week on our website at: www.connecttech.com/sub/support/support.asp. See the contact information section below for more information on how to contact us directly. Our technical support is always free.

Contact Information

Mail/Courier

Connect Tech Inc.
Technical Support
42 Arrow Road
Guelph, Ontario
Canada N1K 1S6

Email/Internet

sales@connecttech.com
support@connecttech.com
www.connecttech.com

Note:

Please go to the [Download Zone](#) or the [Knowledge Database](#) in the [Support Center](#) on the Connect Tech website for product manuals, installation guides, device driver software and technical tips. Submit your technical support questions to our customer support engineers via the [Support Center](#) on the Connect Tech website.

Telephone/Facsimile

Technical Support representatives are ready to answer your call Monday through Friday, from 8:30 a.m. to 5:00 p.m. Eastern Standard Time. Our numbers for calls are:

Toll Free: 800-426-8979 (North America only)

Telephone: 519-836-1291 (Live assistance available 8:30 a.m. to 5:00 p.m. EST, Monday to Friday)

Facsimile: 519-836-4878 (on-line 24 hours)

Limited Product Warranty

Connect Tech Inc. provides a two-year Warranty for the COM Express® Type 7 Carrier Board. Should this product, in Connect Tech Inc.'s opinion, fail to be in good working order during the warranty period, Connect Tech Inc. will, at its option, repair or replace this product at no charge, provided that the product has not been subjected to abuse, misuse, accident, disaster or non-Connect Tech Inc. authorized modification or repair.

You may obtain warranty service by delivering this product to an authorized Connect Tech Inc. business partner or to Connect Tech Inc. along with proof of purchase. Product returned to Connect Tech Inc. must be pre-authorized by Connect Tech Inc. with an RMA (Return Material Authorization) number marked on the outside of the package and sent prepaid, insured and packaged for safe shipment. Connect Tech Inc. will return this product by prepaid ground shipment service.

The Connect Tech Inc. Limited Warranty is only valid over the serviceable life of the product. This is defined as the period during which all components are available. Should the product prove to be irreparable, Connect Tech Inc. reserves the right to substitute an equivalent product if available or to retract the Warranty if no replacement is available.

The above warranty is the only warranty authorized by Connect Tech Inc. Under no circumstances will Connect Tech Inc. be liable in any way for any damages, including any lost profits, lost savings or other incidental or consequential damages arising out of the use of, or inability to use, such product.

Copyright Notice

The information contained in this document is subject to change without notice. Connect Tech Inc. shall not be liable for errors contained herein or for incidental consequential damages in connection with the furnishing, performance, or use of this material. This document contains proprietary information that is protected by copyright. All rights are reserved. No part of this document may be photocopied, reproduced, or translated to another language without the prior written consent of Connect Tech, Inc.

Copyright © 2017 by Connect Tech, Inc.

Trademark Acknowledgment

Connect Tech, Inc. acknowledges all trademarks, registered trademarks and/or copyrights referred to in this document as the property of their respective owners. Not listing all possible trademarks or copyright acknowledgments does not constitute a lack of acknowledgment to the rightful owners of the trademarks and copyrights mentioned in this document.

ESD Warning



Electronic components and circuits are sensitive to Electrostatic Discharge (ESD). When handling any circuit board assemblies including Connect Tech COM Express carrier assemblies, it is recommended that ESD safety precautions be observed. ESD safe best practices include, but are not limited to:

- Leaving circuit boards in their antistatic packaging until they are ready to be installed.
- Using a grounded wrist strap when handling circuit boards, at a minimum you should touch a grounded metal object to dissipate any static charge that may be present on you.
- Only handling circuit boards in ESD safe areas, which may include ESD floor and table mats, wrist strap stations and ESD safe lab coats.
- Avoiding handling circuit boards in carpeted areas.
- Try to handle the board by the edges, avoiding contact with components.

Revision History

Revision	Date	Changes
0.00	2017-03-13	Preliminary Release
0.01	2017-03-14	Add Appendix
0.02	2017-03-17	Update cable kit
0.03	2017-04-17	Add detailed features
0.04	2017-05-19	Update installation notes, and 3 rd party equipment list
0.05	2017-07-11	Added cable drawing links

Introduction

Connect Tech's COM Express® Type 7 Carrier Board is based on the PICMG COM Express® COM.0 R3.0 specification. It includes 2x 10G ethernet from SFP+ modules, 2x Gigabit Ethernet ports, M.2 NVMe Storage, 4x USB 3.0, full and half size Mini PCIe expansion slots, 8x 3.3V buffered GPIO, and a Console connection via Micro USB.

The carrier board is ideal for high-compute, enterprise level applications that have a need for a small form factor rugged solution providing access to high-end Xeon D class processors.

Product Features and Specifications

Specifications	
Compatibility	COM Express Type 7 Modules PICMG COM Express® COM.0 R3.0 Support for current and next-gen Xeon-D (Broadwell DE) processor modules
Network	2 x 10GbE (via SFP+ cages) Integrated 10Gbps PHY located directly on the carrier board Capable of 10GBASE-SR, 10GBASE-LR or 10GBASE-T using when using the appropriate SFP+ transceiver module. 2 x GBE Ports (via RJ-45) 1000BASE-T (10/100/1000Mbps) Capable
Storage	1 x M.2 2280 M-Key Slot (Dual function PCIe + SATA) - NVMe (PCIe x4 Gen3) Capable - SATA III (6Gbps) Capable 1 x Standard SATA Port (7-Pin)
USB	4x USB 3.0 ports
Mini PCIe Expansion	1x mini PCIe slot full size (USB + PCIe) 1x mini PCIe slot half size (USB + PCIe)
Serial	1x CPU Console UART (via Micro USB) 1x General Purpose UART (via 2mm header)
GPIO	8x 3.3V buffered GPIO
Display	Not directly supported, possible through Mini PCIe expansion
Audio	Not directly supported, possible through Mini PCIe expansion
Misc External Interfaces	Reset Button, Power Button, Sys Ctrl
Power	+12V DC only
RTC Battery	Available through header
Dimensions	125mm x 95mm (4.921" x 3.74") 3D model: http://www.connecttech.com/ftp/3d_models/CCG070_3D_MODEL.zip
Operating Temperature	-40°C to +85°C

Part Numbers / Ordering Information

Part Number	
CCG070	Base model

Product Overview

Block Diagram

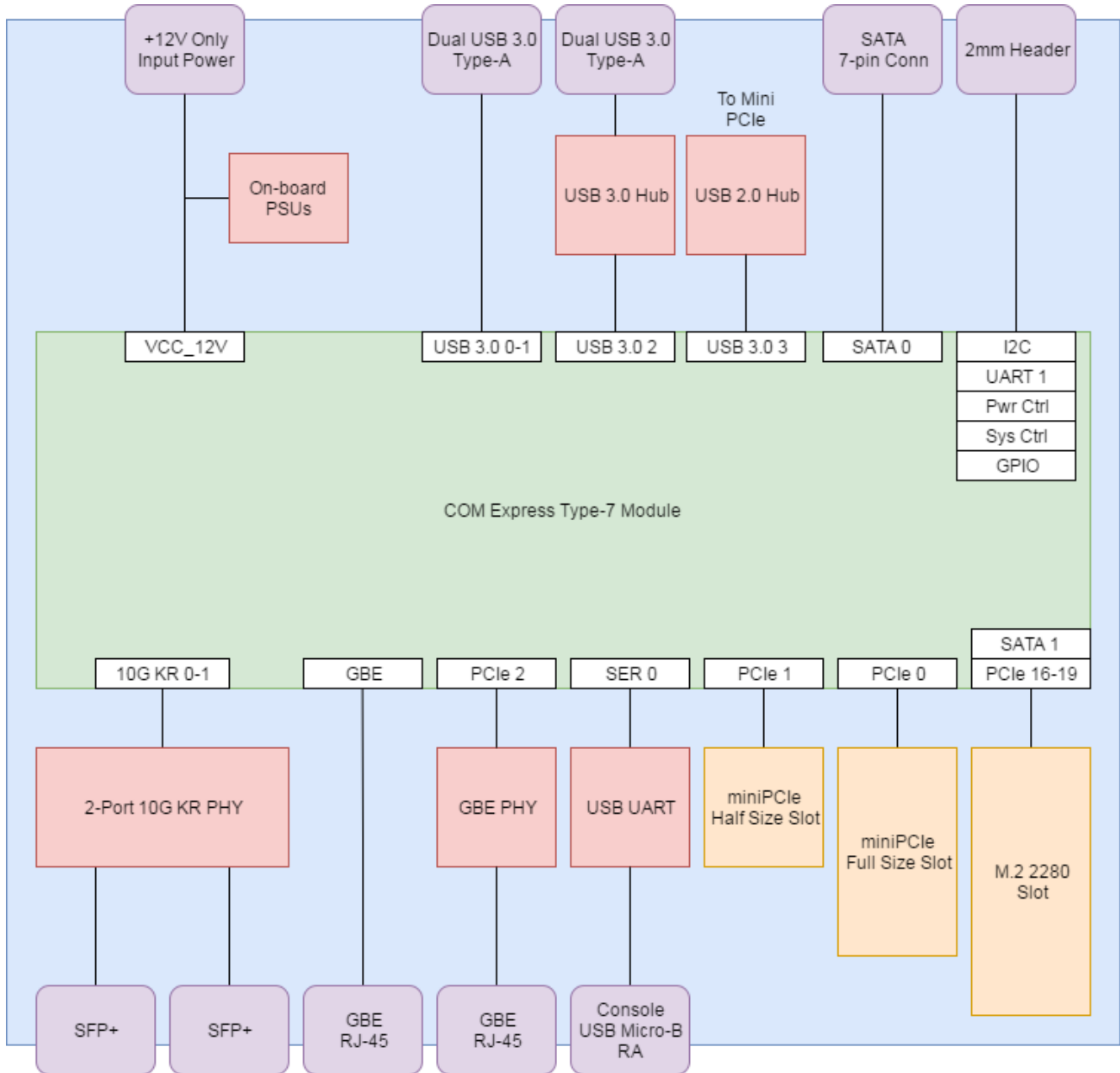

Connector Locations

Top View

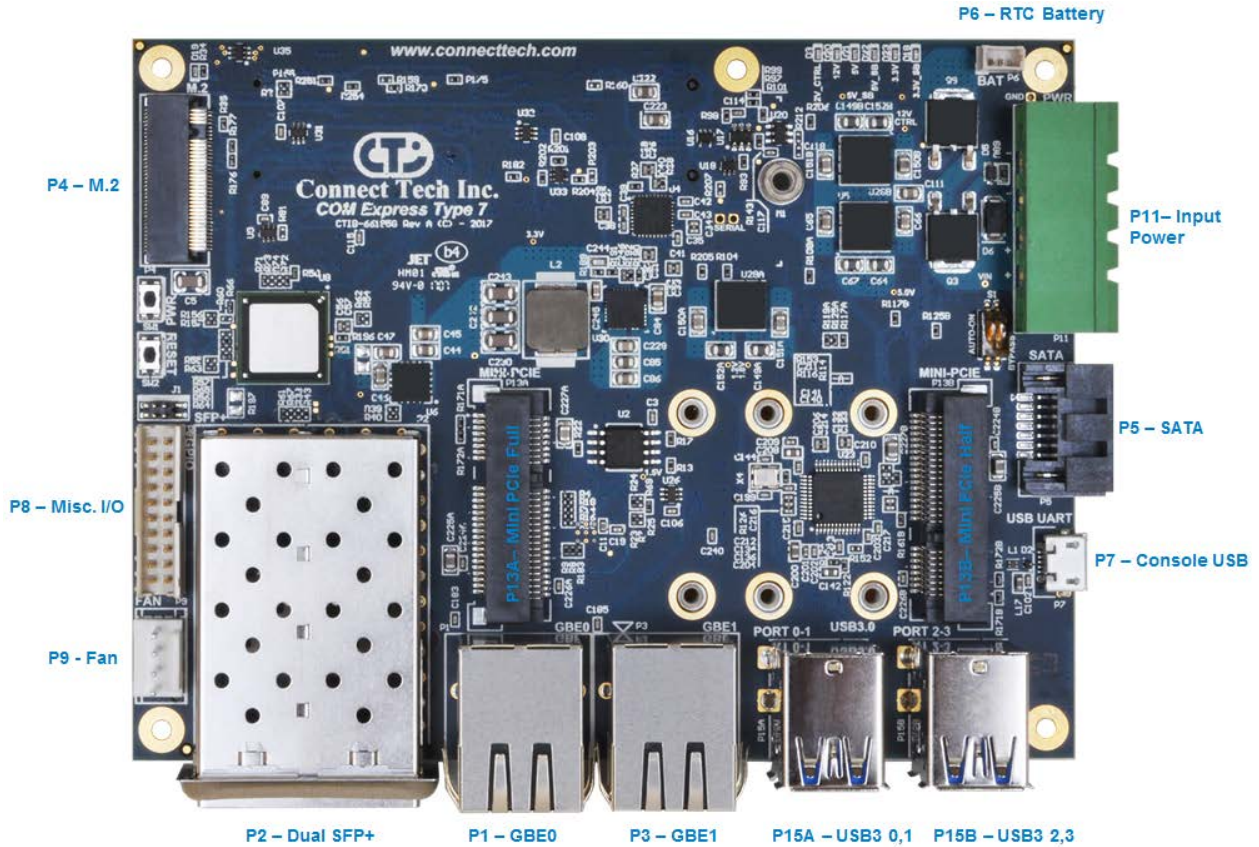

Bottom View

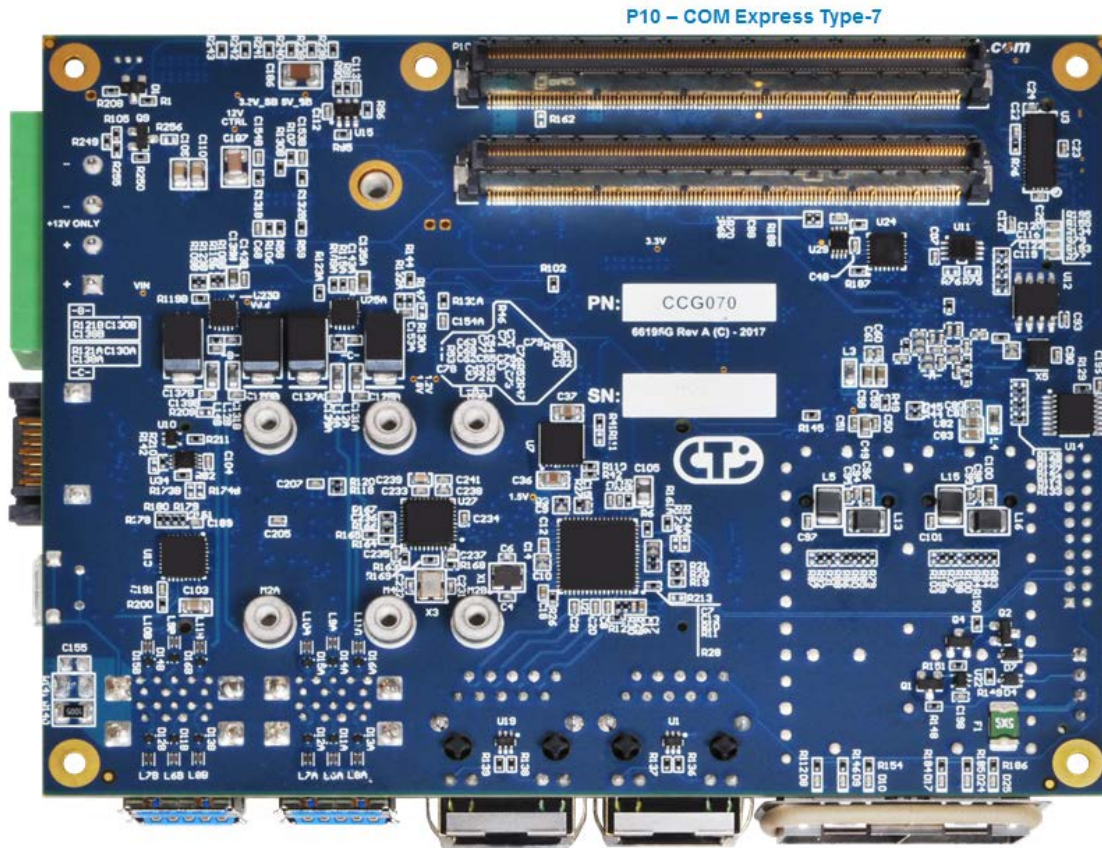

Jumper and Connector Summary

Designator	Description
P1	10/100/1000 Ethernet
P2	Dual SFP+
P3	10/100/1000 Ethernet
P4	M.2
P5	SATA
P6,	RTC Battery
P7	Micro USB Console
P8	Misc. I/O
P9	CPU Fan
P10	COM Express
P11	Input Power
P13A, P13B	Mini PCIe
P15A, P15B	USB 3.0
J1	NVMe selection
S1	Power Selection

Detailed Feature Description

Preface: This section includes pinouts for all non-standard connectors. For all industry standard connectors; the user will need to refer to the appropriate specification provided by the governing body.

COM Express Module Connector

The processor and chipset are implemented on the COM Express Type 7 CPU module, which connects to the COM Express carrier via a Tyco fine pitch stacking connector. 8mm standoffs are required to mount COM Express module. The following table describe how each of Type-7 module interfaces are used and allocated to the carrier resources.

Function	COM Express interface	
Location	P10	
Type	Tyco 3-5353652-6	
Pinout	Refer to PICMG COM Express 3.0	

COM Express Interface Usage and Allocation

Module Interface	Carrier Endpoint	Connection Type	Circuitry Involved
10G KR0	P2	Dual SFP+	KR-SFP PHY
10G KR1	P2	Dual SFP+	KR-SFP PHY
10G KR2	N/A	not used	
10G KR3	N/A	not used	
GBE0	P1	P1 - RJ45	
GPIO (in and out)	<i>not used</i>	<i>not used</i>	
I2C	P8	Header	various
LPC	<i>not used</i>	<i>not used</i>	
NCSI	<i>not used</i>	<i>not used</i>	
PCIe0	P13A	Mini PCIe	
PCIe1	P13B	Mini PCIe	
PCIe2	P3	RJ45	PCIe MAC/PHY
PCIe3-15	<i>not used</i>	<i>not used</i>	
PCIe16-19	P4	M.2	PCIe / SATA mux on 16
PCIe20-31	<i>not used</i>	<i>not used</i>	
SATA0	P5	7 pin SATA	PCIe / SATA mux
SATA1	P4	M.2	
SER0	P7	Micro USB	USB UART
SER1	P8	Header	
SMB	<i>not used</i>	<i>not used</i>	
SPI	<i>not used</i>	<i>not used</i>	
USB0	P15A	USB 3.0	
USB1	P15A	USB 3.0	
USB2	P15B Top, Bottom	USB 3.0	USB 3.0 Hub
USB3 (2.0 only)	P13A, B	Mini PCIe	USB 2.0 Hub

Network

The carrier provides 4 network interfaces. One 10/100/1000 Ethernet direct from the COM Express module, one 10/100/1000 ethernet from a PCIe MAC/PHY, and two SFP+ 10G Ethernet implement use the Type-7 10G BASE KR Interfaces. All connectors are industry standard RJ-45 pinout and SFP+ pinout

Function	Dual SFP+	
Location	P2	
Type	Samtec SFPK-2SL-02-S-TR	
Pinout	Refer to Small Form Factor Pluggable SFF-8431	

Function	RJ-45	
Location	P1, P3	
Type	Pulse JXD0-0001NL	
Pinout	Refer to IEEE 802.3	

USB

The carrier provides 2x Dual USB3.0 connectors. One connector has USB3.0 directly from the COM Express module. The other connector has USB3.0 supplied by a Hub. All connectors are industry standard USB3.0 right angle.

Function	USB	
Location	P15A,B	
Type	TE 1932355-4	
Pinout	Refer to Universal Serial Bus 3.0 Specification	

Bus Expansion

One half sized Mini PCIe and One full sized Mini PCIe are provided. These slots support both a x1 PCIe and USB2.0 connection simultaneously to facilitate using WIFI / Bluetooth combo cards. Both 3.3V and 1.5V are provided to each slot.

These slots DO NOT support mSATA modules and DO NOT have support for external SIM cards.

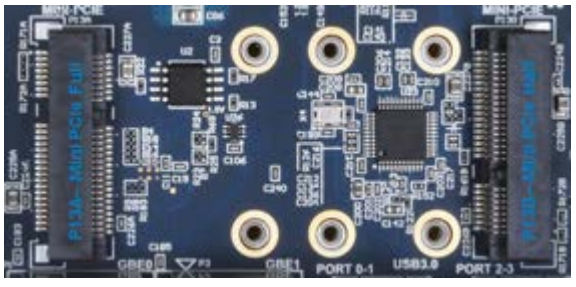
Function	Mini PCIe	
Location	P15A, P15B	
Type	TE 1932355-4	
Pinout	Refer to PCISIG PCI Express Mini Card Electromechanical Specification Revision 2.0	

Storage

The carrier can either be booted from an external SATA HDD/SDD or through an onboard M.2 NVMe or M.2 SATA drive.

The M.2 slot can support either a M.2 x4 PCIe based NVMe or SATA based. The carrier board automatically handles the switching, however J1 can be used to forced the selection. (J1 off = PCIe based, on = SATA based)

Function	M.2, Key M	
Location	P4	
Type	TE 1-2199230-5	
Pinout	Refer to PCISIG PCI Express M.2 Specification	

Function	SATA	
Location	P5	
Type	Molex 0470804001	
Pinout	Refer to SATA-IO Serial ATA	

Serial and GPIO

The carrier provides an on-board USB UART which acts as a USB client to an external USB host; such as a laptop. This allows the user to view the BIOS or OS over USB, providing the module and operating system have been configured correctly. This UART is connected to the SER0 interface of the COM Express module.

Also provided are the SER1 interface (3.3V UART signal levels only), GPIO from an I2C expander, and a connection to the I2C bus.

The GPIO Expander is XRA1200 at address 0x40 (8 bit address).

Function	Micro USB, USB serial Console	
Location	P7	
Type	Molex 47589-0001	
Pinout	Refer to Universal Serial Bus 2.0 Specification	

Function	Micro USB, USB serial Console				
Location	FCI				
Type	FCI 98414-G06-20LF				
Cable	See Cables and Accessories				
Pinout	Pin	Signal	Pin	Signal	
	1	PWRBTN# (*)	2	GND	
	3	SYS_RST# (*)	4	GND	
	5	I2C_SCL (*)	6	GND	
	7	I2C_SDA (*)	8	GND	
	9	GPIO0	10	GPIO4	
	11	GPIO1	12	GPIO5	
	13	GPIO2	14	GPIO6	
	15	GPIO3	16	GPIO7	
	17	SER1_TX (*)	18	GND	
19	SER1_RX (*)	20	GND		
(*) COM Express module signals					

Input Power, RTC Battery and Fan

Input power is provided through a two-part terminal connector. The carrier accepts only a +12V DC input; and uses that to generate all other power rails.

On-board circuitry facilitates an ATX power up scheme, which is controllable through switch S1. The COM Express module's active cooling solution can be connected to the fan connector P9. The COM Express module's RTC battery is supplied through connector P6. Users can provide their own RTC battery solution or purchase one provided by Connect Tech.

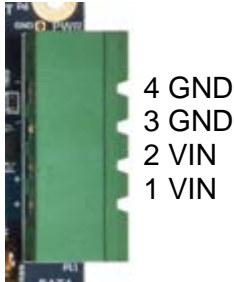
Function	Input Power												
Location	P11												
Type	FCI 20020111-G041A01LF (on board) FCI 20020003-G041B01LF(provided)												
Pinout	<table border="1"> <thead> <tr> <th>Pin</th> <th>Signal</th> </tr> </thead> <tbody> <tr> <td>1</td> <td>VIN</td> </tr> <tr> <td>2</td> <td>VIN</td> </tr> <tr> <td>3</td> <td>GND</td> </tr> <tr> <td>4</td> <td>GND</td> </tr> </tbody> </table>	Pin		Signal	1	VIN	2	VIN	3	GND	4	GND	
Pin	Signal												
1	VIN												
2	VIN												
3	GND												
4	GND												

Function	RTC Battery									
Location	P6									
Type	Molex 53047-0310									
Cable	See Cables and Accessories									
Pinout	<table border="1"> <thead> <tr> <th>Pin</th> <th>Signal</th> </tr> </thead> <tbody> <tr> <td>1</td> <td>VBAT</td> </tr> <tr> <td>2</td> <td>No connect</td> </tr> <tr> <td>3</td> <td>GND</td> </tr> </tbody> </table>	Pin		Signal	1	VBAT	2	No connect	3	GND
Pin	Signal									
1	VBAT									
2	No connect									
3	GND									

Function	CPU Fan, standard 4 pin												
Location	P9												
Type	Molex 22232041												
Pinout	<table border="1"> <thead> <tr> <th>Pin</th> <th>Signal</th> </tr> </thead> <tbody> <tr> <td>1</td> <td>PWM</td> </tr> <tr> <td>2</td> <td>TACH</td> </tr> <tr> <td>3</td> <td>+12VV</td> </tr> <tr> <td>4</td> <td>GND</td> </tr> </tbody> </table>	Pin		Signal	1	PWM	2	TACH	3	+12VV	4	GND	
Pin	Signal												
1	PWM												
2	TACH												
3	+12VV												
4	GND												



Function	Power Selection		
Location	S1		
Type	2x 2 position switch		
Pinout	Switch	State	Function
	1	Off (up)	12V controlled by SUS_S3#
	1	On (down)	12V always on (Bypass)
	2	Off (up)	Manual Power Button
	2	On (down)	Auto Power Button
Both switches Off will produce an ATX style power up sequence.			



RTC Battery

This carrier has a connector P6 providing 3.3V to VBAT, which is the supply for the RTC Clock of the COM Express module.

For further information about RTC battery selection and life time estimation, see Application Note 00009 CTIN-00009 <http://connecttech.com/pdf/CTIN-00009.pdf>

Typical Hardware Installation for +12V power input

1. Ensure all external system power supplies are off.
 2. Install the COM Express module into P10. Be sure to follow the manufacturer's direction for proper heatsink/heat spreader installation and any other cooling instructions from the manufacturer. If active cooling is used plug the 4-pin fan connector into P9.
 3. Install the necessary cables for the application. For the relevant cables, see the Cables & Interconnect section of this manual. Minimum recommended connections:
 - Micro USB for COM Express console redirection into P7
 - RTC Battery cable into P6
 4. Connect the power cable to power supply
 5. Set up console redirection
 - Plug the host end of the Micro USB cable into desktop or laptop system.
 - Assuming a Windows based system, a FTDI serial driver will install. The USB serial circuit is isolated from the rest of the CCG070 carrier and powered from the cable.
 - Run a terminal emulator such as PUTTY, and connect to COM## at 115200 kbps 8N1 (8 bit, 1 stop, no parity). Consult with the module vendor's documentation to confirm these settings.
- NOTE:** not all Type-7 modules have console re-direction enabled by default. Consult the module vendor's documentation for further details.
6. For an initial installation & first time power up:
 - Set the S1 into +12V always on mode (bypass mode) and manual power button.
 - Switch on the power supply – for the very first boot after installing a module into a new carrier a power cycle may be required.

Cables and Accessories

Available from Connect Tech

Drawing No.	Part No.	Description	CKG043
CTIC-00435	CBG116	System-Misc to 20-pin Minitex Cable	1
CTIC-00477	CBG136	RTC Battery Cable	1
OEM	CBG247	Micro USB Cable	1

[CKG043 Cable Kit](#) also available.

Useful Third Party Hardware and Accessories

Assembly Hardware

Manufacturer	Part No.	Description	Qty	Purpose
McMaster-Carr	94669A100	6mm unthreaded spacer, M2.5, AL	4	Mini PCIe install
McMaster-Carr	92000A107	12 mm Philips Pan Head M2.5 Screw SS	4	Mini PCIe install
McMaster-Carr	92000A114	5 mm Philips Pan Head M3 Screw SS	1	M.2 install
McMaster-Carr	94669A615 Or 94669A102	8mm unthreaded spacer, M2.5, AL	5	COM Express module install *
McMaster-Carr	91828A113	2mm nut, M2.5 SS	5	COM Express module install *
McMaster-Carr	92000A112 to 92005A079	25 mm Philips Pan Head M2.5 Screw 30 mm Philips Pan Head M2.5 Screw	5	COM Express module install *

(*) Hardware required will depend on the vendor's cooling solution

Cables and Modules

Manufacturer	Part No.	Type	Description
Innodisk	EMPV-1201-W1	Mini PCIe	Mini PCIe to dual VGA & HDMI(DVI-D Single Link) module
Innodisk	7W9000000080	Cable	Dual VGA Cable for above
Innodisk	7W9000000020	Cable	HDMI Cable for above
Avago	AFBVR-2CAR10Z	SFP+ Cable	10G Ethernet SFP+ Active Optical Cable
Intel	SSDSCKJW180H601	M.2 SSD	SSD 180GB 80mm SATA 6Gb/s, 16nm, MLC
Samsung	MZ-V6E250	M.2 SSD	SSD 250GB PCIe 3.0 x4, NVMe 1.2