



Connect Tech Inc.
Industrial Strength Communications

Blue Heat/Net



Ethernet-to-Serial Communications User Manual

Connect Tech Inc
42 Arrow Road
Guelph, Ontario
N1K 1S6

Tel: 519-836-1291
Toll: 800-426-8979 (North America only)
Fax: 519-836-4878
Email: sales@connecttech.com
support@connecttech.com
Web: www.connecttech.com

Limited Lifetime Warranty

Connect Tech Inc. provides a Lifetime Warranty for all Connect Tech Inc. products. Should this product, in Connect Tech Inc.'s opinion, fail to be in good working order during the warranty period, Connect Tech Inc. will, at its option, repair or replace this product at no charge, provided that the product has not been subjected to abuse, misuse, accident, disaster or non Connect Tech Inc. authorized modification or repair.

You may obtain warranty service by delivering this product to an authorized Connect Tech Inc. business partner or to Connect Tech Inc. along with proof of purchase. Product returned to Connect Tech Inc. must be pre-authorized by Connect Tech Inc. with an RMA (Return Material Authorization) number marked on the outside of the package and sent prepaid, insured and packaged for safe shipment. Connect Tech Inc. will return this product by prepaid ground shipment service.

The Connect Tech Inc. Lifetime Warranty is defined as the serviceable life of the product. This is defined as the period during which all components are available. Should the product prove to be irreparable, Connect Tech Inc. reserves the right to substitute an equivalent product if available or to retract Life Time Warranty if no replacement is available.

The above warranty is the only warranty authorized by Connect Tech Inc. Under no circumstances will Connect Tech Inc. be liable in any way for any damages, including any lost profits, lost savings or other incidental or consequential damages arising out of the use of, or inability to use, such product.

Copyright Notice

The information contained in this document is subject to change without notice. Connect Tech Inc. shall not be liable for errors contained herein or for incidental consequential damages in connection with the furnishing, performance, or use of this material. This document contains proprietary information that is protected by copyright. All rights are reserved. No part of this document may be photocopied, reproduced, or translated to another language without the prior written consent of Connect Tech, Inc.

Copyright © 1997 - 2006 by Connect Tech, Inc.

Trademark Acknowledgment

Connect Tech, Inc. acknowledges all trademarks, registered trademarks and/or copyrights referred to in this document as the property of their respective owners.

Not listing all possible trademarks or copyright acknowledgments does not constitute a lack of acknowledgment to the rightful owners of the trademarks and copyrights mentioned in this document.

Table of Contents

Limited Lifetime Warranty	2
Copyright Notice.....	2
Trademark Acknowledgment.....	2
Certification Statements.....	3
Table of Contents.....	4
Introduction.....	8
Features	8
Understanding virtual COM ports	9
Customer Support Overview	10
Contact Information.....	10
Blue Heat/Net Installation Overview	11
Hardware Installation.....	11
Connecting the Blue Heat/Net to your Network:	11
Direct Connect	11
Connecting to the Network	11
Ethernet LEDs.....	12
Serial Port LEDs	13
Connecting Serial Devices.....	13
RS-232 Connections:	13
Connecting Power	16
Activating the Special Operations Mode and Default Settings.....	16
Using the Reset Button to activate the Special Operations Mode	16
Selecting a Special Operation	17
Power On Diagnostics:	18
LED Error Codes	18
Mounting Bracket.....	21
SCM and TCM Cabling requirements.....	22
SCM: Serial Configuration Manager	22
TCM: Telnet Configuration Manager	22
Setting a Static or Dynamic IP Address.....	23
Set the IP Address using the Web Configuration Manager.....	23
Set the IP Address using the Serial Configuration Manager	23
Blue Heat/Net Configuration	24
CDS (Configuration Data Space)	25
Description.....	25
Access to CDS Parameters.....	25
SCM (Serial Configuration Manager)	26
Description.....	26
Getting Access to the SCM.....	26
SCM Command Reference	26
TCM (Telnet Configuration Manager)	35
Description.....	35
Getting Access to TCM.....	35
TCM Command Reference	36
WCM (Web Configuration Manager).....	38
Signing In to the Web Configuration Manager	38
Configuring Your Blue Heat/Net	39
Monitoring Your Blue Heat/Net	54
Software Installation for Windows	57
Installing the Blue Heat/Net Configuration Manager	57
Running the Configuration Manager	61
Device Installation.....	61
Configure Default Blue Heat/Net.....	61
Add New Blue Heat/Net	62
Auto Discover Blue Heat/Net	62
Configuring the Blue Heat/Net.....	63
Port Mapping	63
Unmap Port(s):.....	70
Remapping Ports.....	71
Port Properties.....	72

Advanced Settings	73
Special Options	73
RS-232	74
RS-485 Options (on RS-422/485 ports)	74
Baud Rate Mapping	74
COM Port Number	74
Scan	75
Defaults Button	75
Replacing your Blue Heat/Net:	75
Removing your Blue Heat/Net:	76
Blue Heat/Net Properties:	76
Driver Removal	76
Software Installation for Linux	77
Installing the Linux host driver	77
Linux host driver setup using auto discovery	77
Firmware Upgrades	78
Upgrade using WCM (Web Configuration Manager)	78
Upgrade using TCM (Telnet Configuration Manager)	78
Upgrade using SCM (Serial Configuration Manager)	78
Appendix	79
Blue Heat/Net Specifications	79
Products	80
Options	80
Protocol Descriptions	81
Pinouts	82
RS-232 and RS-485	82
Cabling Examples:	82
Typical RS-232 null modem connection:	82
Basic "3 wire" RS-232 null modem connection:	83
Connecting to DCE type devices:	83
Loopback Connectors:	84
RS-422/485 Examples:	84
RS-422/485 Wiring Tips:	84
4-wire (full duplex, "RS-422 mode") Wiring hardware flow control	84
Four-wire (full duplex, "RS-422 mode") Wiring without hardware flow control	85
Four-wire (full duplex multi-drop, "RS-485 mode")	85
Two-wire (1/2 duplex, "RS-485 mode") Wiring	86
RS-485 Multi-drop Topology, Two-Wire and Four-Wire	86
Default Settings	87
Network Settings	87
Boot Settings	87
SCM Operation Settings	87
CDS (Configuration Data Space)	87
Common Configuration Setups	88
Static IP Setup	88
DHCP Setup	89
DIN Rail Mounting Option:	90
How the Blue Heat/Net Boots Up	92
Bootup Sequence	93
Flowchart of Special Operations Mode using the reset button	94
Asynchronous communications Tutorial	94
Serial Line Interface Tutorial	95
RS-232 Line Interface:	95
RS-485 Line Interface:	95
Bus contention on RS-485 multi-drop networks:	98
Bias and Termination Resistors in RS-485 networks:	99

List of Figures

Figure 1: LED locations on 2, 4 and 8 port Blue Heat/Net models 12

Figure 2: Typical RS-232 null modem connection 13

Figure 3: Basic 3-wire RS-232 null modem connection 14

Figure 4: Recommended pinouts for loopback connectors. 15

Figure 5: Power connector illustration 16

Figure 6: LED error code example. 18

Figure 7: Web Configuration Manager Sign In 38

Figure 8: Configuring Basic Serial Port Settings (RJ-45 Models)..... 39

Figure 9: Configuring Basic Serial Port Settings (DB-9 Models)..... 40

Figure 10: PPP Call configuration 42

Figure 11: PPP Answer Configuration 44

Figure 12: Raw TCP Server configuration 45

Figure 13: Raw TCP Client configuration 46

Figure 14: Configuring Advanced Serial Port Properties 49

Figure 15: Configuring Security Settings..... 50

Figure 16: Configuring Blue Heat/Net Settings 51

Figure 17: Firmware Upgrades/Downloads 52

Figure 18: Restore Default Settings 52

Figure 19: Saving To Flash..... 53

Figure 20: Monitoring Serial Port Activity 54

Figure 21: Monitoring Network Traffic 55

Figure 22: Monitoring TCP/IP Statistics 55

Figure 23: My Blue Heat/Net Hardware Details 56

Figure 24: My Blue Heat/Net Software Details..... 56

Figure 25: Blue Heat/Net Driver/Software Installation CD..... 57

Figure 26: Blue Heat/Net Software Installation Screen..... 58

Figure 27: Blue Heat/Net Configuration Manager, Installation complete screen 60

Figure 28: My Blue Heat/Net Places screen 61

Figure 29: Add or Auto Discover Blue Heat/Net menu screen 61

Figure 30: Add Blue Heat/Net screen 62

Figure 31: Auto Discover Blue Heat/Net screen 63

Figure 32: Installed Blue Heat/Net screen..... 63

Figure 33: Map Port(s) menu..... 64

Figure 34: Map Port(s) Express method screen..... 65

Figure 35: Found New Hardware Wizard..... 66

Figure 36: Configuration Manager Window after successfully mapping ports 67

Figure 37: Basic Port Mapping option 68

Figure 38: Advanced port mapping interface 69

Figure 39: Port action menu 70

Figure 40: Unmap Port window..... 71

Figure 41: Remap Port window 71

Figure 42: Port Properties window..... 72

Figure 43: Advanced settings window..... 73

Figure 44: Baud Rate Mapping options 74

Figure 45: Replace Blue Heat/Net window 75

Figure 46: Blue Heat/Net properties..... 76

Figure 47: Remove Drivers window..... 76

Figure 48: RS-232 and RS-485 pinouts..... 82

Figure 49: Loopback connectors, DB-9 and RJ-45..... 84

Figure 50: DIN Rail mount option for Blue Heat/Net 2 90

Figure 51: DIN rail mount option for four and eight port DB-9 models..... 91

Figure 52: Bootup sequence..... 93

Figure 53: Bootup sequence via Reset Button..... 94

Figure 54: Typical Asynchronous Data frame 94

Figure 55: RS-232 signals..... 95

Introduction

Connect Tech's Blue Heat/Net enables you to remotely access your RS-232 and RS-422/485 serial devices via your Ethernet LAN or the Internet. Once installed, you can network-enable any device that is designed to be connected to a serial port. Your industrial serial communication devices will no longer be tied to a single computer. The Blue Heat/Net hardware is easy to install, involving little more than plugging the unit into the appropriate locations and performing some simple configuration steps, as outlined in this manual.

Driver setup is made easy by the Blue Heat/Net's auto-detection feature. The software does the work of locating the units, and the Configuration Manager leads you through the rest of the setup process.

The Blue Heat/Net's firmware is easily configured with a choice of methods: web browser, Telnet, or direct serial connection with a terminal and/or terminal software. Once you've configured the Blue Heat/Net to your specifications, you'll be able to start remotely accessing your devices immediately.

Features

- Includes an auto-sensing 10Base-T, 100Base-TX LAN interface
- Programmable uClinux embedded operating system running on a ColdFire embedded processor
- Power over Ethernet (PoE) option for 2 port models
- Free Software Development Kit available
- Serial ports on the unit can be linked to one or more remote computers via an Ethernet LAN and accessed using standard serial applications
- MDI/MDI-X autodetect cabling feature prevents improper cabling connections on 2 port model (enables use of cross-over or straight through cable)
- Serial ports can be run at speeds up to 460.8 Kbps on RS-422/485 ports (and RS-232 ports on 2 port models) and 230.4 Kbps on RS-232 ports (4 and 8 port models)
- Full modem control and hardware flow control pins on all ports
- Supports IP, TCP, UDP, ARP, RARP, TFTP, DHCP, BOOTP, HTTP, PPP, Telnet and DNS
- Use of TCP/IP means communications can be routed to support WANs as well as LANs. The Blue Heat/Net does not have to be located in the same site as the controlling computer
- Point-to-Point Protocol (PPP) client and server
- Raw TCP client and server
- Several levels of security are built into the Blue Heat/Net that can limit connections and help ensure the privacy of data flow
- Network boot or booting from built-in Flash Memory
- Firmware upgrades are downloadable
- Configuration of Blue Heat/Net units can be done via Web Browser, Telnet or direct serial connection
- Software switchable RS-232/422/485 with bias/termination models are available
- Front mounted diagnostic LEDs
- Wall mount bracket included
- DIN Rail mount available on DB-9 models

Understanding virtual COM ports

In a typical serial port setup, the application communicates directly with the connected serial port hardware.

Virtual COM ports differ in that the application communicates with a network protocol layer that transfers the necessary information to and from the remote serial ports. The virtual ports appear as standard serial ports to the application, but in reality, the data is translated into a series of Ethernet messages between the Blue Heat/Net unit and the host computer. The serial port is not physically connected to the host computer, but this is transparent to the application trying to access it.

There are several advantages to using virtual COM ports, which include:

- **Distance** – The serial ports can be a very long distance away from the host computer. They are not limited by the standard electrical characteristics of the RS-232 or RS-422 interface because the primary data transfer is being done via Ethernet. Depending on the set up, these serial ports can be at a different location and the Internet can act as the carrier of the serial port traffic.
- **Speed** – Short RS-232/422 cable lengths can be used with the primary distance relying on the network connection. The capacitance of long lengths of serial cable does not limit data speeds in these cases.
- **Cabling** – Cost effective Ethernet cabling can be used for the transfer of information to the Blue Heat/Net and often this is part of the existing networking infrastructure. Putting some serial ports in a remote location can be as easy as plugging in a Blue Heat/Net to the Ethernet Network. This provides a simple, clean cabling arrangement.
- **Port Sharing** – In some applications, it is desirable to have a serial resource that is accessed and shared by more than one host computer. Connect Tech's Virtual Serial Port technology allows this to be done easily.
- **Routing** – Different ports on a Blue Heat/Net can be connected to multiple host computers.
- **Monitoring** – The Virtual Serial Ports can easily be monitored to ensure everything is working correctly because they are on the network.

Customer Support Overview

If you experience difficulties after reading the manual and/or using the product, contact the Connect Tech reseller from which you purchased the product. In most cases the reseller can help you with product installation and difficulties.

In the event that the reseller is unable to resolve your problem, our highly qualified support staff can assist you. Our support section is available 24 hours a day, seven days a week on our website at:

www.connecttech.com/sub/support/support.asp. See the contact information section below for more information on how to contact us directly. Our technical support is always free.

Contact Information

We offer three ways for you to contact us:

Telephone/Facsimile

Technical Support representatives are ready to answer your call Monday through Friday, from 8:30 a.m. to 5:00 p.m. Eastern Standard Time. Our numbers for calls are:

Telephone: 800-426-8979 (North America only)

Telephone: 519-836-1291 (Live assistance available 8:30 a.m. to 5:00 p.m. EST, Monday to Friday)

Facsimile: 519-836-4878 (on-line 24 hours)

Email/Internet

You may contact us through the Internet. Our email and URL addresses are:

sales@connecttech.com

support@connecttech.com

www.connecttech.com

Mail/Courier

You may contact us by letter and our mailing address for correspondence is:

Connect Tech Inc.

Technical Support

42 Arrow Road

Guelph, Ontario

Canada N1K 1S6

Note:

Please go to the [Download Zone](#) or the [Knowledge Database](#) in the [Support Center](#) on the Connect Tech website for product manuals, installation guides, device driver software and technical tips.

Submit your technical support questions to our customer support engineers via the [Support Center](#) on the Connect Tech website.

Blue Heat/Net Installation Overview

There are three main stages in the installation process for your Blue Heat/Net.

1. [Hardware Installation](#)
This involves the physical connection of the Blue Heat/Net hardware to your network, and addresses issues such as cabling and power requirements.
2. [Blue Heat/Net Configuration](#)
The first step in the configuration process is to set the [IP Address](#). Then use one of three available methods to configure the Blue Heat/Net firmware settings for your application. This can be done through the Serial Configuration Manager, Telnet Configuration Manager, or the Web Configuration Manager, depending on circumstances and personal preference.
3. [Software Installation and Configuration of Blue Heat/Net drivers](#)
This step installs and configures the Blue Heat/Net drivers and ports for your host Operating System, and allows you to set parameters specific to your serial requirements. This is done via the Blue Heat/Net Configuration Manager.

Hardware Installation

Connecting the Blue Heat/Net to your Network:

Before you begin, take a minute to ensure that your package includes the required components that should have shipped with your Blue Heat/Net.

- One Blue Heat/Net unit
- One power supply
- One CD containing software and documentation
- One Quick Start Guide
- One Phoenix contact screw terminal plug (2-port PoE models)
- One RJ-45 cable (optional)
- One DB-9 female to DB-9 female null modem cable (optional)

If any of these components is missing, [contact Connect Tech](#) (See Contact Details) or your reseller.

NOTE: The Blue Heat/Net 2 port model features an MDI/MDI-X Autodetect feature. The pinouts will adjust automatically to accommodate the use of a null Ethernet cable or a straight through cable.

Direct Connect

Direct connect is an Ethernet connection made directly from Blue Heat/Net to the Ethernet jack on your computer.

This connection is achieved using a **cross-wired Ethernet cable, also known as a null Ethernet cable**. These cables can be assembled yourself (see [appendix](#) for pinouts) or purchased from any electronics or computer store.

Connecting to the Network

The most common method involves connecting your Blue Heat/Net to network hardware at the facility where you are installing the Blue Heat/Net device. The hub or switch could be in a network closet in your building, or locally on your desk or workbench. This connection is achieved using a **straight through Ethernet cable**; a standard Ethernet cable readily available from any electronics or computer store. (See [appendix](#) for pinouts.)

Note:
Connect Tech recommends you use quality Category 5 cables or better when connecting to the Blue Heat/Net Ethernet jack.

Ethernet LEDs

On 4 and 8 port Blue Heat/Net models, the front panel features Ethernet and Serial Port LEDs to monitor activity. The left front side of the box features five LEDs. (Two port models feature the CPU LED on the face of the device between the two serial port LEDs. The 10/100 and Link/Activity (L/A) indicators are located on the top). Their usage is as follows:

- Power:** When this LED is on, the Blue Heat/Net is receiving line power. (Some models do not have this LED)
- CPU:** Once the uClinux firmware is booted and running correctly, this LED appears as a continuous light.
- 10/100:** This LED represents the speed at which the Blue Heat is connected to your Network.
 - LED on = a 100 megabit connection.
 - LED off = a 10 megabit connection.(The Blue Heat/Net automatically senses the speed.)
- L/A:** (2 port models only). This light is on when a link or connection to a network or computer is achieved. A blinking light indicates that Transmit (Tx) or Receive (Rx) activity is detected on the Ethernet cable.
- Link:** (4 and 8 port models) The Link light is on when a connection to a network or computer is achieved.
- Act.** (4 and 8 port models) This LED indicates that Transmit (TX) or Receive (RX) activity is detected on the Ethernet cable.

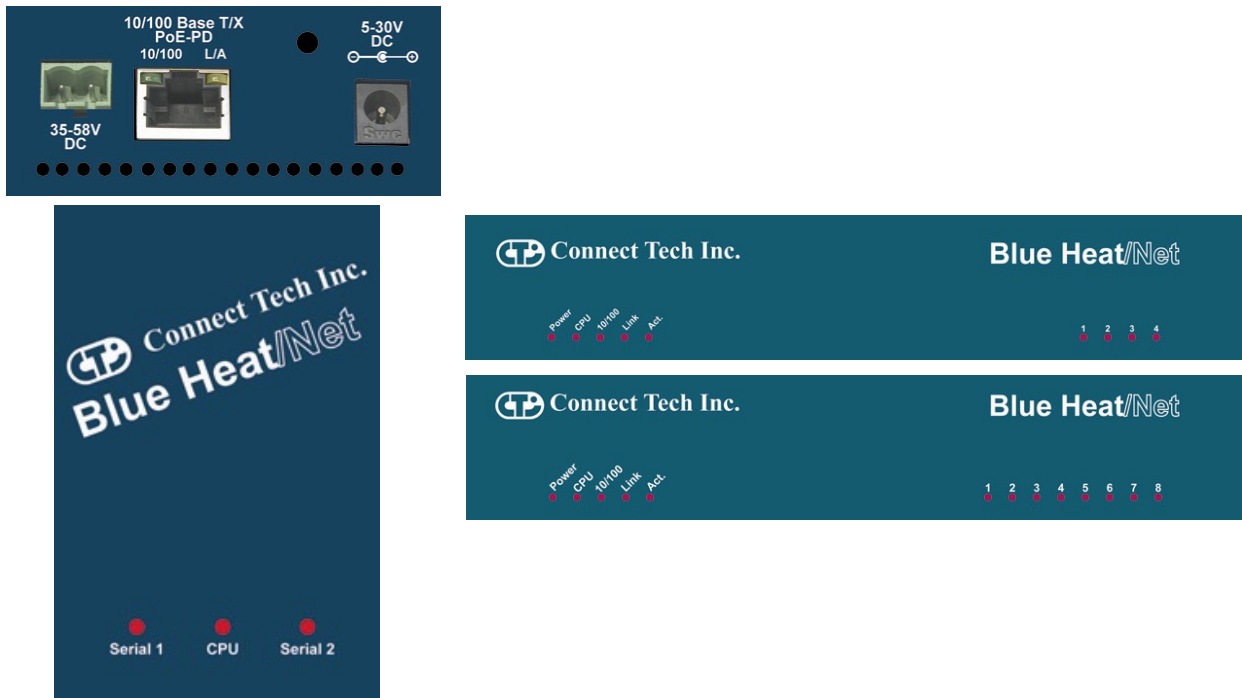

Figure 1: LED locations on 2, 4 and 8 port Blue Heat/Net models

Serial Port LEDs

The serial ports LEDs (two, four or eight, depending on your model) indicate serial activity for each port.

- A flashing LED indicates that the port in question is receiving or transmitting data.
- BN001-004 models: If the LED is on, there is an RS-232 connection detected on the RS-232 serial port.

Connecting Serial Devices

RS-232 Connections:

Typical RS-232 null modem connection

This is the typical way to connect to DTE type devices, such as the Blue Heat/Net. It is used when hardware RTS-to-CTS flow control is required. The cable required is called a cross-over

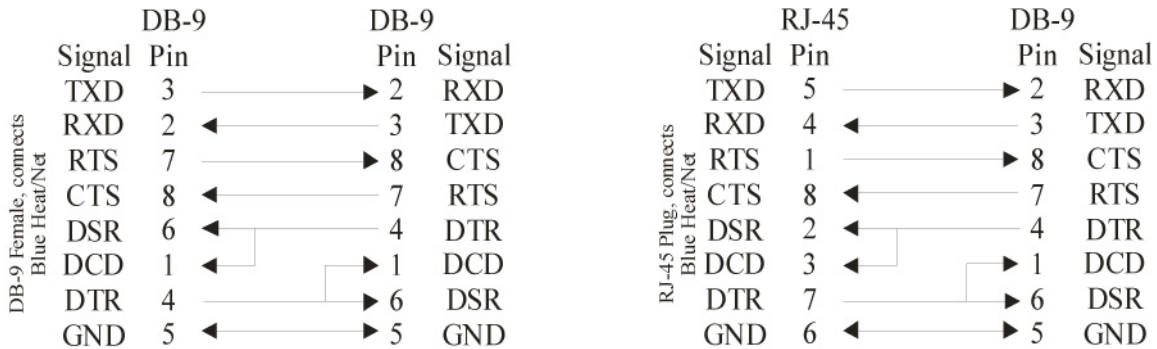

or null modem cable, and is readily available at any electronics retailer/distributor.

Figure 2: Typical RS-232 null modem connection

Basic 3 wire RS-232 null modem connection:

Used to connect to DTE type devices like the Blue Heat/Net, this connection is used when hardware RTS-to-CTS flow control is NOT required. The cable is called a cross-over cable, and is readily available at any electronics retailer/distributor.

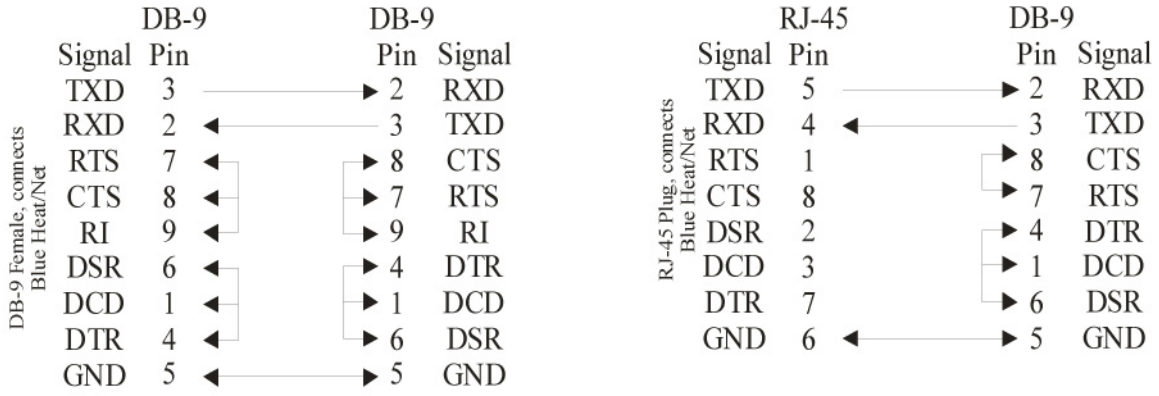

Figure 3: Basic 3-wire RS-232 null modem connection.

Connecting to DCE type devices:

DCE type devices do not require a null modem cable; instead, they require a straight through cable. Straight through cables, both DB-9 to DB-9 and DB-9 to DB-25, are commonly available.

The following is an example of a DB-9 female cable to a DB-25 male cable to connect to a modem.

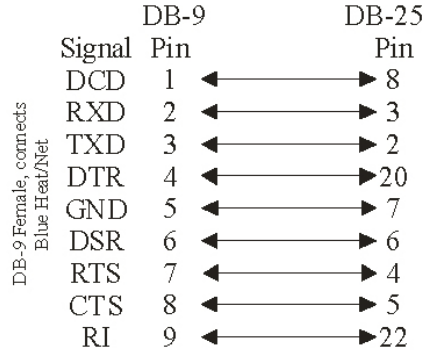

Figure 4: DB-9 female to DB-25 male for modem connection.

Loopback Connectors:

Loopback connectors are useful for performing diagnostics. The following are the recommended pinouts for creating loopback connectors for your Blue Heat/Net products.



Figure 4: Recommended pinouts for loopback connectors.

DB-9: For DB-9 female loopback connectors we recommend solder cup DB-9 connectors and 28 AWG solid core wire.

RJ-45: For RJ-45 loopback connectors, we recommend 8 pin RJ-45 connectors and about 2 inches of CAT 5 cable. You will have to crimp the wires from the CAT 5 cable into the RJ-45 plug, then strip and solder the wires to match the above loopback pinout.

Connecting Power

The Blue Heat/Net uses a standard DC power jack for power input. The Blue Heat/Net can be safely connected or disconnected at any time. The standard power supply requirements are as follows:

Two port models

Models BN009 and BN0010

- 0.75A DC, 5 to 30 Volts unregulated.

Model BN011, Power over Ethernet (PoE) and Screw terminal power

PoE: To use Power over Ethernet, the BN011 must be connected to an IEEE 802.3af compliant "PSE" Power Sourcing Equipment, such as a PSE Hub or PSE Switch

Screw Terminal Power: Use the provided Phoenix screw terminal connector Phoenix SMSTB 2,5/2-ST-5.08 to power 36-56V DC. The power input is polarity independent. The acceptable wire size is 14-24 AWG, 2.08-0.20 mm².

Four and Eight port models

Models BN001 to BN004

- 1A DC, 5 to 6 Volts unregulated.

Models BN005 to BN008

- 2A DC, 5 Volts regulated.

Power Connector:

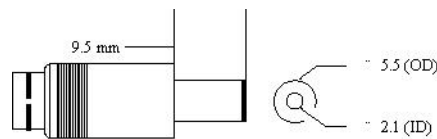

Figure 5: Power connector illustration.

Note:

The center is positive, outside is ground (0V).

Activating the Special Operations Mode and Default Settings

On Blue Heat/Net models with software selectable line interfaces, there is a small reset button located on the rear surface. On two port models, it is located between the DB-9 connectors. This push button can be used to perform special operations, such as resetting the unit to its default settings, or to force port scanning in situations where the SCM is not accessible.

Using the Reset Button to activate the Special Operations Mode

To activate the Special Operations Mode, hold the reset button while the unit is powering up. Hold the button until **all** the port LEDs **blink rapidly**. Release the reset button. The port LEDs will continue to flash rapidly after the reset button is released to indicate the Special Operations Mode is active.

Selecting a Special Operation

After the **Special Operations Mode** has been activated ([see instructions](#)), there are four options as described below:

1. **Abandon the Special Operations Mode**

To abandon this mode without selecting a special operation, press and hold the reset button for at least four seconds. While the button is pressed, the rapid flashing of the port LEDs will stop. After four seconds, the rapid flashing will resume, you can now release the reset button. After you release the button, the port LEDs will all be off, indicating that the Special Operations Mode has terminated.

2. **Cancel a Special Operation**

If you need to cancel a special operation after it has been selected, repeatedly press the reset button until all the port LEDs begin to flash rapidly. Then abandon the Special Operations Mode by pressing the reset button for four seconds, as explained above.

3. **Select a Special Operation**

Operations are selected by repeated **short presses** of the reset button. Each time the reset button is pressed; it is **counted** and represented on the port LEDs as a **binary number**, with the port 1 LED the least significant bit. (see Table 1.) Choose the operation which you want to perform. If you miss the selection which you want (press the button too many times), keep pressing the button, the count starts over again once it reaches 7 (1111 binary).

4. **Activate a Special Operation**

To activate a selection, press and hold the reset button for at least four seconds. During this time, the rapid flashing of the port LEDs will stop. When the rapid flashing resumes, you can release the reset button. The port LEDs will turn off, indicating that the Special Operations Mode has been activated.

Table 1: Special Operations Available

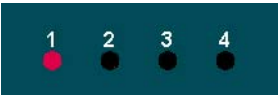
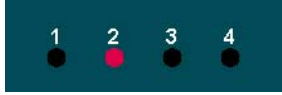
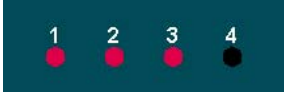
Special Operation	Number of presses (and binary representation)	Usage
Force port scanning to first two ports (Scanning runs until current scanning delay setting times out. Default is 30 seconds.)	ONE press 	This forces the first two ports to RS-232 mode, causing the SCM to scan these ports and thereby allowing access to the SCM. (see note below)
Force port scanning to all ports. (Scanning runs until the SCM is entered or until the unit is powered down. There is no time out.):	TWO presses 	This forces all ports to RS-232 mode, therefore all ports are scanned for SCM use. The Blue Heat/Net will behave in the same manner as an RS-232 only model. (see note below)
Restore factory default settings	SEVEN presses 	This restores the factory default settings for ALL configuration parameters.

NOTE: Why would I need to force port scanning?

Some line interface settings are inappropriate for SCM use. During boot up, the SCM scans only those ports set for RS-232 or RS-485 Full-Duplex mode. If all of the ports are configured for another mode, (1/2 Duplex or Multi-drop) SCM port scanning is bypassed, and the SCM application cannot be accessed. Use of either of the "Force Port Scanning" operations outlined in [Table 1](#) will force port scanning to occur so the SCM application can be accessed.

Power On Diagnostics:

LED Error Codes

If an error is detected during the bootup process, an error **condition** and **code** are displayed on the LEDs on the face of the Blue Heat/Net.

- The error **condition** is signaled by a rapidly flashing CPU LED (about 10 to 20 per second).
- The error **code** is displayed on Port LEDs 1 to 4 as a binary number on four and eight port models, and is represented in two port models by the behavior of the Serial 1 and Serial 2 LEDs (see chart below).



Figure 6: LED error code example.

In the above example, a rapidly flashing CPU LED during the boot up process signifies the Blue Heat/Net has experienced an error. The port LEDs 1 through 4 signify which error has occurred; in this case, LED 2 and 3 are on, so the error code is 6. The chart below defines the error details for each error code.

Table 2: LED error codes for Blue Heat/Net

2 port LED key:

CPU rapid error flash
(50 ms on/off)





Slow flash
(1 s on/off)





Fast flash
(.25 s on/off)

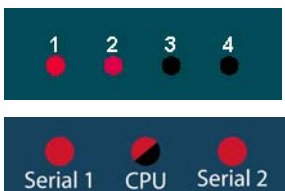

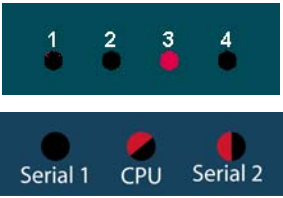
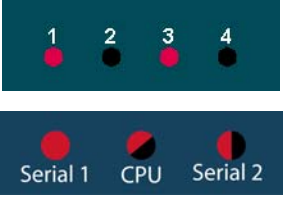
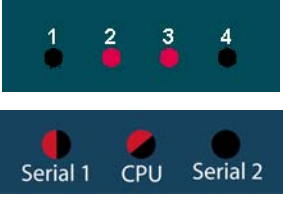
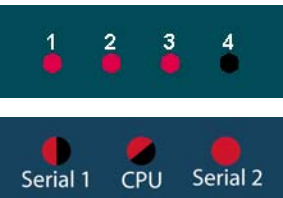
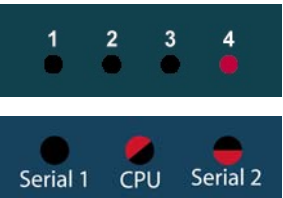
Error Code and Event	Details	Suggested Corrective Action
<p>1. Loader code in Flash is erased.</p> 	<p>The regions of Flash memory which hold the Loader code are both erased. (There are 2 redundant Loaders in Flash which can be run).</p>	<p>This may occur in electrically noisy environments or if there are ESD disturbances. If this error persists, it may be a hardware issue. Contact Connect Tech.</p>
<p>2. Loader code in Flash has a bad CRC.</p> 	<p>The regions of Flash memory which hold the Loader code both have CRC errors. (There are 2 redundant Loaders in Flash which can be run).</p>	<p>See corrective action for error code 1</p>
<p>3. RAM copy of Loader code has a bad CRC.</p> 	<p>The Loader code is copied to RAM before execution. This error is shown if the RAM copy has a CRC error.</p>	<p>See corrective action for error code 1</p>

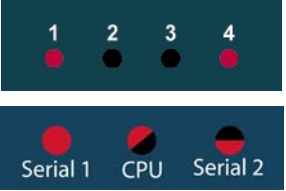
<p>4. Configuration Data Space (CDS) areas have corrupted data (CRC failure).</p> 	<p>The CDS is copied from Flash to RAM during the beginning of the Loader code. If a CRC error is detected in the RAM copy, this error is shown.</p>	<p>See corrective action for error code 1</p>
<p>5. Can't obtain an Operating System image (uClinux) to run.</p> 	<p>This will occur when any of the enabled boot sources (Flash or BOOTP/TFTP or TFTP) fail to obtain a valid compressed Operating System image to run.</p>	<p>Check network connections, server computer or your unit's settings. This error occurs if TFTP booting is enabled, and the BH/Net can't download the file from the server. Contact Connect Tech if it persists.</p>
<p>6. Unexpected return from the uClinux Operating System.</p> 	<p>This error occurs if the Operating System returns back to the Loader which is NOT supposed to occur.</p>	<p>See corrective action for error code 1</p>
<p>7. CDS (re)programming failure.</p> 	<p>Certain CDS items are updated during the bootup. If a failure occurs during the re-programming of this region of Flash, this error will occur.</p>	<p>See corrective action for error code 1</p>
<p>8. Boot Count could not be incremented in Flash memory</p> 	<p>This error is usually caused by a Flash memory failure.</p>	<p>Contact Connect Tech</p>

<p>9. No ports found (NOTE: Error displays on LEDs 5-8 on 8 port models, 1-4 on 4 ports)</p> 	<p>This message usually indicates a UART component failure.</p>	<p>Contact Connect Tech</p>
<p>15. Mismatched CDS version number</p> 	<p>uClinux checks the CDS version number against its expected CDS version number, if they are different uClinux does not continue its operation.</p>	<p>If you have updated the uClinux code via SCM and haven't updated the Loader/SCM code, this error appears on reboot. Update companion Loader code and reboot.</p>

Mounting Bracket

The 4 and 8 port Blue Heat/Nets feature a simple vertical mounting bracket. First fasten the mounting bracket to the vertical surface, then slide the Blue Heat/Net onto the bracket. The bracket is designed so that the serial port connectors face down.

A DIN Rail Mount option, sold separately as part number MS009 consists of two brackets with DIN rail mount clips. (See appendix for more information about [DIN rail mounting](#).)

The 2 port Blue Heat/Net has built-in wall mount flanges that accept a number of connection options. DIN rail mount clips are available as part number MS010

SCM and TCM Cabling requirements

SCM: Serial Configuration Manager

The Serial Configuration Manager is used to configure the Blue Heat/Net via a serial port. The Serial Configuration Manager is discussed in greater detail later in this document. To access the Serial Configuration Manager you will need to connect an RS-232 serial cable from your standard computer serial port to any RS-232 port on the Blue Heat/Net. The cabling required to connect to the Blue Heat/Net is as follows:

Blue Heat/Net products with RJ-45 connectors:

These models ship with optional DB-9 female to RJ-45 Jack adapters (PN: CB005) and a straight through Ethernet cable, 2 meters (6.5 ft) in length (PN: CB006). Follow the steps below:

1. Plug the CB005 adapter into your PC serial port.
2. Plug either end of the CB006 cable into the CB005 adapter.
3. Plug the other end of the CB006 cable into any RS-232 RJ-45 serial port on the Blue Heat/Net.

If you don't have a CB006 or CB005 cable, you can make your own SCM cable, from a DB-9 female, some length of CAT 5 cable and a RJ-45 plug. See the "[Typical Null Modem Cabling](#)" section in the Connecting Serial Devices Section.

Blue Heat/Net product with DB-9 male connectors:

Any null modem serial cable with DB-9 female connectors will work. Simply connect your null modem serial cable from the PC serial port to any RS-232 port on your Blue Heat/Net.

TCM: Telnet Configuration Manager

The Telnet Configuration Manager is used to configure the Blue Heat/Net in much the same way as the Serial Configuration Manager. You will need to connect your Blue Heat/Net to your network through a hub or switch or through a direct connection to your computer.

Network Connection

Connect the Blue Heat/Net to your network hardware using a standard straight through CAT 5 network patch cable. A patch cable is optionally available with the Blue Heat/Net, part number: CB006.

Direct Connect

You can connect your Blue Heat/Net directly to a computer without a hub or switch. You will need standard cross-wired CAT 5 network patch cable.

Setting a Static or Dynamic IP Address

Prior to configuring your Blue Heat/Net, you must set a static or dynamic IP address. The default IP address of a new Blue Heat/Net is 192.168.42.1. If there is a possibility that this has been changed, you will need to find the current IP address setting before you begin.

The easiest way to get the IP address of your Blue Heat/Net is as follows:
Follow the steps outlined in the section [Installing the Blue Heat/Net Configuration Manager](#), noting your Blue Heat/Net's IP number (i.e. A.B.C.D) using the [Auto Discover Blue Heat/Net](#) feature.

Set the IP Address using the Web Configuration Manager

Note: If you use the Windows Configuration Manager and use Auto Discover to locate your Blue Heat/Net on the network, you can right-click and launch the Web Configuration Manager from there.
You only need to use the route add command if you choose not to use the Configuration Manager found on the CD that accompanied your Blue Heat/Net.

From the command prompt of your computer, run: `route add A.B.C.0 mask 255.255.255.0 <current IP of your host machine>` Be sure to replace the .D from the Blue Heat/Net's IP with a 0 (zero). Open your browser and put the Blue Heat/Net's IP in the address bar (i.e. A.B.C.D) This will open the WCM.

Log in (default login is `wcm` and the default password is `password`) and assign the static IP or change the IP to 0.0.0.0 if you are using a DHCP assigned IP.

Set the IP Address using the Serial Configuration Manager

Insert your CD into the computer. The Driver/Software Installation menu should appear. If it doesn't, double-click on `ctisetup.htm`.

Click `View` in the Blue Heat/Net Software section and then `Connect` in the Serial Configuration Manager section. This will launch HyperTerminal that comes with Windows XP.

Unplug the power to the Blue Heat/Net and plug it back in. Light indicators 1 to 8 (or 1 to 4) will blink sequentially. This sequential flashing will last for 30 seconds. You must log in during this window.

During this sequential flashing, type the word `password` into the HyperTerminal window. Be careful you don't miss the window of opportunity to enter the password.

You now have access to the Serial Configuration Manager (SCM). An `scm>` prompt is ready to accept commands. If you do not see this prompt, unplug the power and repeat the steps above.

If you wish to set a dynamic IP address enter the following:

```
net dhcp=yes
save
exit
```

If you wish to set a static IP address, enter the following, substituting `xxx.xxx.xxx.xxx` with the static IP you wish to assign:

```
net mip=xxx.xxx.xxx.xxx
save
exit
```

Close the HyperTerminal. You may now disconnect the RJ-45 cable from your PC and connect it to any serial device.

Blue Heat/Net Configuration

The Blue Heat/Net comprises several software components, each of which manages various functions of the Blue Heat/Net. The following is a breakdown of these components.

- **Operating System Software**
 - Host Operating System Driver
 - Configuration Manager
 - Web browser (Host Operating System supplied)

- **Blue Heat/Net Software (Firmware)**
 - Embedded Operating System (uClinux)
 - Kernel
 - Drivers
 - Ethernet
 - Serial
 - Flash
 - Blue Heat/Net Ethernet Protocol Converter application (Ctid)
 - Web server (Boa)
 - Web pages
 - Telnet services
 - PPP Client and PPP Server
 - Bootloader
 - Serial Configuration Manager (SCM) Application
 - Configuration Data Space (CDS)

The following section describes in brief what each main component controls.

Host Operating System Driver

The Host Operating System driver performs the translation from a standard Serial COM port interface to the Blue Heat/Net protocol (which is then delivered to the LAN as described above).

Configuration Manager

This software manages and configures the relationships between the Blue Heat/Net serial ports and the COM port assignments of the Host Operating System.

Web Browser

The Host Operating System supplies a Web Browser to support the Web Configuration Manager (WCM) used to change the configuration settings of Blue Heat/Net units.

Embedded Operating System

The embedded Operating System is uClinux.

PPP Client and PPP Server

A Blue Heat/Net port can behave as a PPP connection, enabling you to run network protocols over a serial link. PPP connections are often used in applications that require remote monitoring. You can set the Blue Heat/Net to behave as either the dial out or “client” side (PPP Originate) or the answering or “server” side (PPP Answer).

Bootloader

This code first starts up the embedded processor of the Blue Heat/Net from a power-up or software initiated reboot. It then obtains the Embedded Operating System image (file) from one of several locations and runs the Operating System.

Serial Configuration Manager (SCM) Application

This application is used to change the configuration settings of Blue Heat/Net units by connecting to a serial port on the Blue Heat/Net from a terminal (or terminal emulation program on a PC).

Configuration Data Space (CDS)

This is the area, in non-volatile (Flash) memory, which stores the configuration parameters.

CDS (Configuration Data Space)

Description

The Blue Heat/Net has a number of configuration parameters which are stored in a **Non-Volatile** (Flash memory) area. (See appendix for list of parameters)

The **CDS** area is stored **redundantly** in the Flash memory along with a **CRC**-style checksum to ensure data integrity.

Access to CDS Parameters

The parameters stored in the **CDS** can be changed through the use of the following configuration tools:

SCM Serial Configuration Manager
TCM Telnet Configuration Manager
WCM Web Configuration Manager

These three methods allow the user to change Configuration Parameters by whichever method is most convenient. In some cases several methods will be employed during different stages of the setup of the Blue Heat/Net, for example:

The SCM may be employed in the beginning when the unit is not connected to a network and various networking parameters need to be set up prior to connection to a network.

TCM or WCM may be employed after the unit is connected to a network, possibly to modify other settings related to Serial Ports, Bootup settings or others.

More information about the operation of the [SCM](#), [TCM](#) and [WCM](#) follows.

Note:

When CDS Parameters are changed via the SCM, TCM or WCM, some settings will not take effect until the Blue Heat/Net is next rebooted or powered up.

SCM (Serial Configuration Manager)

Description

The Serial Configuration Manager is one of the applications you can use to access the Configuration Data Space (CDS) settings of the Blue Heat/Net. Since the CDS stores the default serial port settings, it is important that the line mode is configured prior to first use. Otherwise, you'll not be able to access the ports.

Getting Access to the SCM

To access the SCM, you simply connect a serial port terminal device (or a PC running a terminal emulator program) to any of the serial ports on the Blue Heat/Net, and enter a correct **Password**. A command prompt is then sent to the terminal and CDS Parameters can be changed using a command line style of entry.

Note:

For RJ-45 models, the Blue Heat/Net ships with the unit configured to scan all serial ports on the unit for entry of the Password. This behavior can be changed by alteration of one of the CDS parameters.

If your Blue Heat/Net model has **configurable line interfaces (DB-9 models)**, certain settings can affect access to the SCM. The ports are scanned as follows:
The default Line mode setting of **all** ports is **Undefined**. Under these conditions, the first two ports are set to RS-232 mode during port scanning. Access to the SCM is available through these ports only. (You should set all ports to a known state prior to use.)
When a port is set to something other than **Undefined**, any port with a setting of RS-232 or RS-485-Full Duplex will be scanned. Otherwise, scanning is not performed, and access to SCM is not available.

Note:

To access the Blue Heat/Net via the SCM your serial line interface settings must be at the default values of 9600 baud, 8 data bits, no parity and 1 stop bit (9600, 8, n, 1). No flow control is recommended.

In a situation where port scanning is not performed, you can still access the SCM using the push button reset on the back of the unit. Follow the instructions in the section [Activating the Special Operations Mode and Default Settings](#) to access the SCM in this situation

See the section which describes How the Blue Heat/Net Boots for a complete description of the **Bootup** process of the Blue Heat/Net and how to access the SCM.

SCM Command Reference

SCM commands are entered as strings of ASCII characters with options separated by whitespace characters. The entire command line is terminated by a CR character or CR/LF character pair.

Command lines can be entered manually (via a terminal or a PC with terminal emulator program) or sent from an application program. There is no character-to-character minimum timing restriction. The command line buffer is limited to the size of the FIFO on the serial port, which is **64** characters for the RJ-45 model and 128 for the DB-9 model of the Blue Heat/Net.

If an SCM command is entered with no options specified, the command shows the syntax of its options and the current setting of those options.

Brief Command List

- **boot** Bootup settings
- **cfg** SCM operational settings
- **exit** Exits the SCM application (and optionally reboots the Blue Heat/Net)
- **help** Brief list of available commands and their syntax
- **info** Blue Heat/Net general information and Flash verification
- **net** Network settings
- **port** Serial port settings, line interface settings and UART information
- **pson** Personality settings
- **save** Save setting changes to Non-volatile (Flash) storage
- **update** Download (via TFTP) and Flash a new Operating System (uClinux) and Loader/SCM image.

Command Details

boot

Syntax: **boot** [mode=] [file=] [delay=]

Description: This command establishes the Blue Heat/Net boot-up mode. For a detailed description of the boot-up process of the Blue Heat/Net, see How the Blue Heat/Net Boots up in the Appendix.

Options: **mode=**
 A comma-separated list of the following sub-options. Each sub-option is preceded by either a + or a – to indicate if the sub-option is enabled or disabled.
±flash Enables or disables the ability to boot from the Flash memory.
±bootp Enables or disables the ability to obtain the boot-up information from a Server.
±tftp Enables or disables the ability to download and boot from a file located on a Server.

file=
 This option specifies the default file name used for the boot-up (if TFTP boot is enabled) and also the default file name when using the **flos** command. This can be any sequence of characters up to 128 characters in length. (The default is **BHNUCLinux_vvv.gz**, where **vvv** is the current version number of the “Operating System image”).

delay=
 This sets the time duration for accessing the SCM application. It can be set from 2 to 30 seconds, the **default is 30**. (See the section How the Blue Heat/Net Boots up for more information).

cfg

- Syntax:** **cfg [port=] [timeout=] [password=] [prompt=] [file=]**
- Description:** Establishes the settings used by the SCM application to modify its behavior.
- Options:**
- port=**
 Specifies the port number to scan for a password to gain entry in the SCM.
 N = Scan just port N (N=1 to the number of ports on the unit).
 255 = Scan all ports on the unit (default unless unit has programmable line interfaces).
- timeout=**
 Specifies the time duration allowed for a TCM (via telnet) session to be idle (no activity) before the session is terminated.
 0 to 1092 minutes
 (default = 5)
 Note: A setting of zero allows infinite timeout.
- password=**
 This sets the password phrase, which is used to gain access to the SCM, TCM and WCM modes of configuring the Blue Heat/Net. The default is "password".
- prompt=**
 This setting controls whether a password prompt (and other password entry status information) is presented to the terminal. This prompting is helpful for new users of the product but may present a problem when other devices are connected to the serial port.
 yes enables the password prompting (default)
 no disables the password prompting
- file=**
 This sets the file name used as a default when using the **fldr** command. It can be any sequence of characters up to 128 characters in length. (The default is "BHNloader_vvv.gz", where vvv is the current version number of the "Loader").

exit

- Syntax:** **exit [-nosave] [-no_reset][-login]**
- Description:** This command is to exit the SCM and reboot the Blue Heat/Net. If CDS changes have been made a warning message is issued and the SCM will not exit.
- Options:**
- nosave**
 Exit without saving changes (abandon changes).
- no_reset**
 Exit SCM without rebooting, maintaining the changes to settings for this session only. (Booting is continued after the SCM is exited.)
- login**
 Exit without saving changes, and restart the SCM login process.

help

- Syntax:** **help**
- Description:** Displays a brief list of all the commands.
- Options:** There are no options for the help command. Please note that specific help for the options of each command can be obtained by entering any command with a single “?” argument. An example would be **net ?**

info

- Syntax:** **info [-v]**
- Description:** This command is used to show basic information about the Blue Heat/Net unit, like Serial Number and Version Numbers, and performs a confidence (CRC and Decompression verification) test of the contents of the Flash memory.
- Options:** **-v**
This option disables the confidence tests.

net

- Syntax:** **net** [**network= | net=**]
 [**my_ip= | mip=**]
 [**server_ip= | sip=**]
 [**gateway_ip= | gip=**]
 [**subnetmask= | snm=**]
 [**broadcast_ip= | bcip=**]
 [**dns_ip=**]
 [**domain=**]
 [**host name=1 host=**]
 [**tcp=**]
 [**mac=**]
 [**dhcp=**]
- Description:** Establishes the network settings.
- Options:** **network= | net=**
Sets the “network” portion of the IP address into **my_ip**, **server_ip** and **gateway_ip**. The address entered is masked by the subnet mask setting before being applied. This command is a shortcut for quickly setting all the IP addresses of the unit. See note below.
- my_ip= | mip=**
This sets the IP address of the Blue Heat/Net unit (default is 192.168.42.1). See note below.
- server_ip= | sip=**
This sets the Server IP address. This address determines the address of the Server to use when the **Bootp** and **tftp** mode is enabled (see **boot** command), and also as the default Server address to use for the **update** commands (default is 0.0.0.0). See note below.
- gateway_ip= | gip=**
This sets the Gateway IP address. This address is used when the **Bootp** mode is enabled, default is 0.0.0.0. See note below.

subnetmask= | snm=

This sets the Subnet mask IP address. (The default is 255.255.255.0) See note 1.

broadcast_ip= | bcip=

This sets the Broadcast IP address. This is used when the **Bootp** mode is enabled. (The default 255.255.255.255). See note below.

dns_ip=

This sets the IP of Domain Name Server. (The default is 0.0.0.0). This must be set to update the Blue Heat/Net firmware automatically from Connect Tech's anonymous ftp server.

domain=

This sets the Domain name of the unit. (The default is blueheat.net)

Host name=1 host =

This sets the Host name of the Blue Heat/Net unit. (The default is BHNsssssss, where "sssssss" is the serial number of the unit).

tcp=

This sets the base TCP port number used for Host TCP/IP and UDP/IP communications. The default is 49152 (0xC000)

mac=

This displays the MAC address of the unit. (The default is 00:0C:8B:SS:SS:SS, where SS:SS:SS is the hex value of the serial number of the unit). Note: The MAC address **cannot** be changed, it can only be displayed.

dhcp=

This enables or disables DHCP support.

yes enables

no disables (default)

Notes:

All IP addresses are entered in common IP address notation: ddd.ddd.ddd.ddd where ddd is a decimal number from 0 to 255.

IP address "my_ip, server_ip, gateway_ip and dns_ip" can be entered right justified, meaning that the address entered will be applied to the specified address starting from the least significant digit, masked by the subnet mask. For example:

If the subnet mask is set to 255.255.255.0, and the following command is entered:

net net=12.23.34.00 mip=45 sip=56 gip=67 dns_ip=89

The following IP addresses result:

the Blue Heat/Net unit will be	12.23.34.45
the Server will be	12.23.34.56
the Gateway will be	12.23.34.67
and the DNS IP will be	12.23.34.89

port

Syntax: **port** [port#]
 [line_mode= | lmode=]
 [baudrate= | baud=]
 [data_bits= | bits=]
 [parity= | par=]
 [stop_bits= | stop=]
 [software_flow= | sflow=]
 [xoff=]
 [xon=]
 [hardware_flow= | hflow=]
 [local_loopback= | llb=]
 [special_char_mode= | scm=]
 [error_char= | errch=]
 [break_char= | brkch=]
 [event_char= | evtch=]
 [use_xoff_xon_limits= | xlim=]
 [xofflim=]
 [xonlim=]
 [escape_char= | esc=]
 [fifos=]
 [txload=]

Description: This command establishes the initial settings of the serial ports when the Blue Heat/Net is powered up.

Options: **port#**
 This specifies the port number to change or query. If the port number is omitted, the command returns a summary of all the ports on the Blue Heat/Net.
N where N is 1 to the number of ports on the unit.

line_mode= | lmode=

This is used to change the Line Interface Mode settings on units supporting this feature.

232	Sets RS-232 mode
full	Sets RS-422/485 Full-Duplex mode
4wire	Sets RS-422/485 4-Wire Multi-drop mode
2wire	Sets RS-422/485 2-wire Multi-drop mode (½ Duplex)
±tri	Enables or disables line driver Tri-State at power-up. (Valid only with RS-422/485 Full Duplex mode.)
±bt	Enables or disables Line Bias and Termination on RS-485 ports

baudrate= | baud=

This sets the baud rate.

50 to 460800 (default 9600, maximum 230400 baud on RJ-45 models)

data_bits= | bits=

This sets the number of data bits in each character (byte).

5, 6, 7 or 8 (default)

parity= | par=

This sets the parity mode

n	no parity (default)
e	even
o	odd

0 force 0 (space parity)

1 force 1 (mark parity)

stop_bits= | stop=

This sets the number of stop bits

1 (default)

1.5

2

software_flow= | sflow=

This sets the software (xon/xoff) flow control mode.

n none (default)

r receive (xoff is transmitted when the FIFO buffer fills, xon is transmitted when FIFO buffer is emptied)

t transmit (transmit will stop when xoff is received, and resume when xon is received)

b both receive and transmit

xoff=

This sets the xoff character (entered as a HEX value).

0 to FF (default is 13)

xon=

This sets the xon character (entered as a HEX value).

0 to FF (default is 11)

hardware_flow= | hflow=

This sets the hardware (RTS/CTS) flow control mode, using a comma-separated list of the following sub-options. Each sub-option is preceded by either a + or a - to indicate if the sub-option is enabled or disabled.

±cts

When enabled, the transmission will stop when the CTS signal goes off, and will resume when CTS goes on.

±rts

When enabled, RTS will go off when the FIFO buffer fills, and will go on again when the receiver buffer empties.

±dsr

When enabled, the transmission will stop when the DSR signal goes off, and will resume when DSR goes on. (Currently not supported.)

±dtr

When enabled, DTR will go off when the FIFO buffer fills, and will go on again when the FIFO buffer empties. (Currently not supported.)

±rts_toggle | ±rtog

This establishes the toggle mode of the RTS signal. In this mode the RTS signal goes on before a block of transmit characters and goes off at the end of the block. (Currently not supported.)

Example: **hflow=+cts,-rts**

The default for **hflow** is all flags disabled.

fifos=

This enables or disables the use of the FIFOs on the UART channel.

yes enabled

no disabled

The default is **yes**.

txload=

This sets the maximum number of bytes to load into the transmitter FIFO.
1 to the FIFO size of the UART (default is FIFO size)

The following options are not implemented

[local_loopback= | llb=]

[special_char_mode= | scm=]

[error_char= | errch=]

[break_char= | brkch=]

[event_char= | evtch=]

[use_xoff_xon_limits= | xlim=]

[xofflim=]

[xonlim=]
 [escape_char= | esc=]

pson

Syntax: `pson [port#][p=][flags=][+d]`

Description: This command sets the Personality or profile of a port. It establishes the application that will use the port.

Options: **port#**
 This specifies the port number. This number can be any valid port number starting at 1 to the number of ports available on the particular Blue Heat/Net unit. If the port number is omitted, the command returns the personality of all ports on the Blue Heat/Net.

p=
 This sets the personality string to the value supplied (up to 32 characters). Default is `ctid_portd`.

flags=
 This sets the personality flags to the value supplied (entered as a HEX value). 0 to 0xFFFF. Default is 0x0001 (RE_SPAWN)

+d
 This sets the personality flags to the default values.

Note:
 The [p=] and [flags=] options are only available when the user logs into SCM using the "backdoor" password. Contact [Technical Support](#) for this password.

save

Syntax: `save`

Description: This command saves the setting changes into the CDS in the non-volatile (Flash) memory.

Options: (none)

update

Syntax: `update <-os | -loader | -jffs> [server_ip= | sip=] [file=]`

Description: Download and store (in Flash memory) a new uClinix Operating System image or a new Loader/SCM image. The download is conducted by a TFTP download from a Server. After download the image file is checked as being a valid gzip file (file is decompressed to validate its contents), and then the file is stored in Flash memory. The **OS** file is stored in Flash in its compressed form, but the **Loader** is stored uncompressed.

Options: **-os | -loader | -jffs**
 Use **-os** to update the uClinix OS.
 Use **-loader** to update the loader/SCM.
 Use **-jffs** to update the JFFS system (Journaling Flash File System).

server_ip= | sip=
 Specify the Server IP address from which the file is to be downloaded.

file=

Specify the file name to download. If the -jffs option is chosen, then the file= option is mandatory.

Note:

After downloading, the image is checked to ensure the file is correctly formatted. If the file is bad the command exits. The version is checked against your current version. If they match, you will be prompted to choose if you wish to program the Flash. Enter "y" to continue. If the version is different, the new version needs to be saved with the save command when the update is finished.

When the JFFS is updated, all previous contents are destroyed. Only use this option when updating to a Blue Heat/Net that supports Personality settings.

TCM (Telnet Configuration Manager)

Description

The Telnet Configuration Manager (TCM) is an application similar to the SCM. The TCM provides the same functionality as the SCM, and offers some additional features.

Getting Access to TCM

The TCM is accessed via a telnet connection to the Blue Heat/Net unit. Any standard telnet application program can be used, (i.e PuTTY). If you are using DHCP to dynamically assign an IP on your network, use the [Blue Heat/Net Configuration Manager](#)'s Auto Discover to determine the IP assigned to your unit.

Telnet to the assigned IP address and enter the log in and password information. Once a telnet session is established, the user is prompted for a log in. Use the log in tcm, and the same password used to access the SCM application. Upon successful log in the user will encounter a similar interface as the SCM application.

TCM Command Reference

The TCM commands contain the SCM commands, in addition to other commands unique to the TCM. The TCM commands have the same syntax as the [SCM](#) (see previous section). A brief command list is provided below. Please note that the * denotes commands not available through the SCM application. Following this brief list are command details for the TCM-unique commands.

Brief Command List

- **boot** Bootup settings
- **cfg** TCM operational settings
- **exit** Exits the TCM application
- **help** Brief list of available commands and their syntax
- **info** Blue Heat/Net general information and Flash verification
- **net** Network settings
- **port** Serial port settings, and UART information
- **save** Save setting changes to Non-volatile (Flash) storage
- **update** Downloads (via TFTP) and programs Flash with Loader/SCM image and Operating System (uClinix) image.

Commands unique to the TCM

- **sec** Serial Port Security Settings *
- **stats** Network or port statistics *

Command Details

stats

Syntax: **stats [option]**

Description: This command displays the statistics for a particular network protocol or the serial driver statistics.

Options: **txrx**
This displays the number of bytes transmitted or received for each port. It also shows which port is open, and by what IP, along with a summary of serial errors. PFO errors are the sum of parity, frame and overrun errors that have occurred for a particular port.

error
This second serial statistic option provides a breakdown of PFO errors. In addition the number of serial breaks encountered is shown for each port.

tcp
This displays attributes related to the network TCP protocol.

ip
This displays attributes related to the network IP protocol.

udp
This displays attributes related to the network UDP protocol.

icmp
This displays attributes related to the network ICMP protocol.

sec

Syntax: **sec [port#] [options]**

Description: This command changes the permission lists for each port. Each port has an IP address white list. The white list contains the IP addresses checked each time a serial port is opened through the network. If the client's IP is not in the list the client will be denied access to that serial port. If the list is empty then any client may open the port. If there is a lockout associated with the list then no client can access the list. The *sec* command allows you to display and edit these IP security white lists. The permission level is used to allow access to groups of commands.

Options: **port#**

This specifies the port number. This number can be any valid port number starting at 1 to the number of ports available on the particular Blue Heat/Net unit.

list

This displays the current white list for the specified port. Remember, if the list is empty, any client (any IP) can access the port. There is no sub option for this command.

clear

This removes all IP addresses from a list, thus allowing any client to access the port. This command also clears the lockout if it exists. There is no sub option for this command.

rm

This command is used in conjunction with the list command. The user typically examines the IP white list and makes note of which entry needs to be removed. You must note the record number that appears to the left of the IP. Use this record number as a sub option to the *sec/rm* command, in order to remove a desired IP.

add

This appends new IPs to a given list. The sub option for the *sec/add* command is a valid IP in dot-number notation. You may want to execute the list command to confirm that an IP was successfully added.

lockout

This list is used to deny access to the specified serial port. There is no sub option for this command. The lockout can be eliminated with a clear command.

Examples:
sec 1 list Display the IP white list for port number 1.
sec 5 clear Clear the IP white list for port number 5.
sec 3 add 210.98.82.99 Add IP 210.98.82.99 to the white list for port number 3.
sec 3 rm 1 Remove the 1st entry in the white list for port number 3.

WCM (Web Configuration Manager)

Signing In to the Web Configuration Manager

You will need to know the IP address of your Blue Heat/Net unit before you use the Web Configuration Manager. Use the Serial Configuration Manager to assign the Blue Heat/Net a valid IP address, or tell the Blue Heat/Net to use DHCP to automatically obtain an IP address. Please refer to the [Serial Configuration Manager](#) documentation for information on how to do this.

Once you know your IP address, open your web browser and go to: http://_your_ip_address or <http://www.hostname.com>

You will arrive at the Blue Heat/Net Web Configuration Manager Sign In page. The default username is `wcm`. Leave this name as-is. The default password is `password`. Use this username/password combination and click the **Sign In** button to log on to the Web Configuration Manager.



Figure 7: Web Configuration Manager Sign In

Once you have signed in, you should immediately change the default password.

At this point you should be directed to the Web Configuration Manager homepage. To sign out of the Web Configuration Manager, just click on the **Sign Out** link on the upper right-hand side of the Web Configuration Manager.

Configuring Your Blue Heat/Net

There are five main configuration options for your Blue Heat/Net. These include basic serial settings, advanced serial settings, security settings, Blue Heat/Net settings and Firmware. The Reboot and Change your Password options are also located here. The options for each configuration screen are described in the following sections.

Configure Basic Serial Settings

Signed In: wcm@192.168.42.3 [Help](#) [Sign Out](#)

Your Blue Heat/Net IP
192.168.42.1

Blue Heat/Net [Save To Flash](#)

This section allows you to configure the default serial port settings. These are the settings used when the port opens. The driver or application that opens the port usually overrides these settings.

Port	Baud Rate	Parity	Data Bits	Stop Bits	Flow Control	Personality	
Port 1	9600	none	8	1	none	PPP Answer	Configure
Port 2	9600	none	8	1	none	BlueHeat/Net	Configure
Port 3	9600	none	8	1	none	BlueHeat/Net	Configure
Port 4	9600	none	8	1	none	BlueHeat/Net	Configure
Port 5	9600	none	8	1	none	BlueHeat/Net	Configure
Port 6	9600	none	8	1	none	BlueHeat/Net	Configure
Port 7	9600	none	8	1	none	BlueHeat/Net	Configure
Port 8	9600	none	8	1	none	BlueHeat/Net	Configure

Figure 8: Configuring Basic Serial Port Settings (RJ-45 Models)

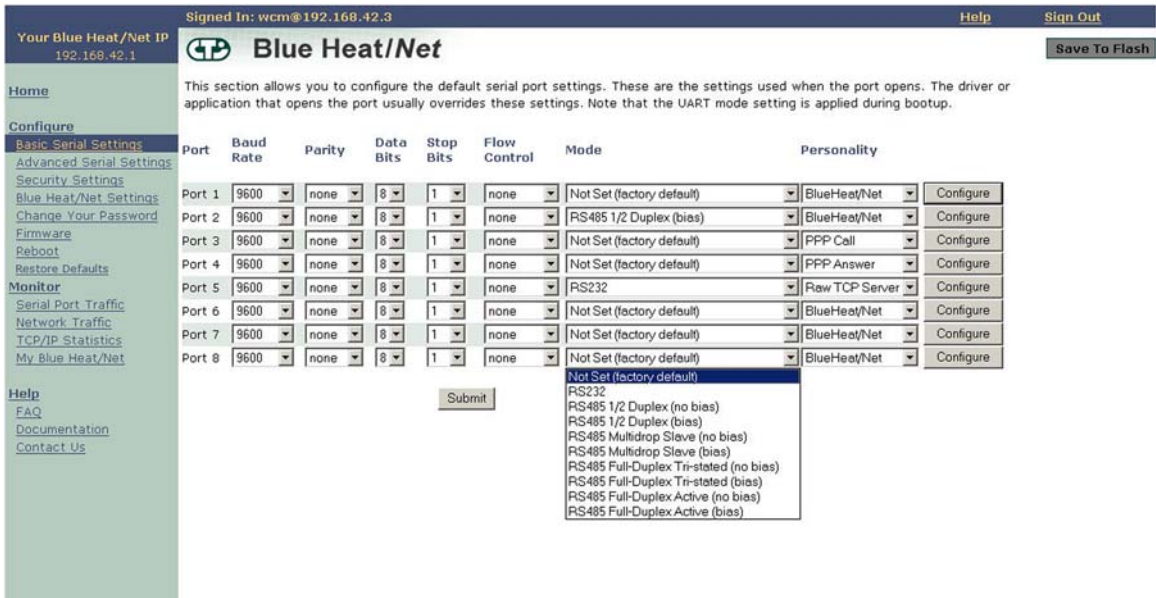

Figure 9: Configuring Basic Serial Port Settings (DB-9 Models)

This page contains basic or common serial settings. Here you can configure the default baud rate, parity, start bits, stop bits and flow control for each of your Blue Heat/Net ports. DB-9 models include a Mode option to set the line interface mode. The initial values for each port are:

- 9600 baud
- no parity
- 8 data bits
- 1 stop bit
- no flow control
- Mode: Not Set (factory default) * or port disabled
- Personality: Blue Heat/Net

*DB-9 models only.
 NOTE: Line modes should be changed to a specific setting. The Windows host driver settings will override line mode settings, so ensure the mode you choose is in agreement with the OS advanced properties port setting.

Change the serial port settings as required, and click the **Submit** button at the bottom of the page. A confirmation page will be presented to you to inform you that your changes have been saved. (Note: These settings are usually overridden by applications you use with the Blue Heat/Net.)

Basic settings also offers a **Personality** option. This enables you to set the personality or communication protocol of your ports based on your application requirements. The personalities include:

- **Blue Heat/Net:** This is the default option and refers to the normal behavior of the Blue Heat/Net port. In most applications, the default setting will suit the application. There is no need to set anything beyond the regular configuration options of the Web Configuration Manager.
- **PPP Call:** This configures your Blue Heat/Net port to behave as a PPP (Point-to-Point Protocol) connection. It configures the port to treat your PC as the client, or “dialing” side of the connection. Choose PPP Call and click on the Configure button to set further options.
- **PPP Answer:** This configures your Blue Heat/Net port to behave as a PPP connection from as a server (answer) side of the PPP connection. Choose PPP Answer and click on the Configure button to set additional options.
- **Ethernet to serial:** Currently disabled.
- **Raw TCP Server:** This configures your Blue Heat/Net port to listen for an incoming TCP connection from a remote computer or device.
- **Raw TCP Client:** This configures your Blue Heat/Net port to connect via TCP to a remote computer or device at a specific IP address.

Point-to-Point Protocol (PPP) Options

It is possible to configure a Blue Heat/Net port to behave as a PPP connection. This enables you to run network protocols over a serial link. This link can be a direct serial connection using a null modem cable, or a modem link via telephone, cell or satellite line. PPP connections are often used in applications that require remote monitoring. You can set the Blue Heat/Net to behave as either the dial out or “client” side (PPP Call) or the answering or “server” side (PPP Answer). The Blue Heat/Net can act as both PPP server and client simultaneously if more than one serial port is used.

The screenshot shows the Blue Heat/Net web interface. The top navigation bar includes "Signed In: wcm@192.168.42.3", "Help", and "Sign Out". The main content area is titled "Blue Heat/Net" and contains a "Save To Flash" button. The interface is divided into a left sidebar with navigation links and a main configuration area.

Left Sidebar:

- Home
- Configure
 - Basic Serial Settings
 - Advanced Serial Settings
 - Security Settings
 - Blue Heat/Net Settings
 - Change Your Password
- Monitor
 - Serial Port Traffic
 - Network Traffic
 - TCP/IP Statistics
 - My Blue Heat/Net
- Help
 - FAQ
 - Documentation
 - Contact Us

Main Configuration Area:

This section allows you to configure the files that initiate and define your point-to-point connection. The options file provides options to pppd. *# man pppd* on a Linux machine will describe the available options.

The chat file provides the connection script. *# man chat* on a Linux machine will describe the format and operation of the script.

chap-secrets stores the username and password information for the CHAP protocol.

pap-secrets stores the username and password information for the PAP protocol.

The secrets files are only used if the appropriate authorization protocol has been configured in the options file.

Options configuration file

```
19200
modem
connects
auth
lock
192.168.0.254:192.168.0.1
```

Chat configuration file

```
#!/bin/sh
PHONE_NUMBER=5551212
DTERMINATE=test
PASSWORD=justtesting

chat -v -e \
TIMEOUT 5 \
ABORT '\r\n\r\n'
```

PAP configuration file

```
# Secrets for authentication using PAP
# client server secret IP addressess
test * test *
```

CHAP configuration file

```
# Secrets for authentication using CHAP
# client server secret IP addressess
test * test *
```

A "Submit" button is located at the bottom of the configuration area.

Figure 10: PPP Call configuration

For more detailed information about using PPP, visit www.tldp.org/HOWTO/PPP-HOWTO/index.html

PPP Call

Choose PPP Call and click **Configure**. The PPP Call configuration page consists of four script files. The **Options configuration** file includes system default information such as baud rate, modem connection, flow control, peer authorization and IP addresses (local and remote) assigned to the port. See the Linux manual page `pppd` (`# man pppd`) for a full list of options. The **Chat configuration** file defines the dialog that occurs between client and server during connection. See the Linux manual page `chat` (`# man chat`) for a full list of options. The **PAP (Password Authentication Protocol)** and **CHAP (Challenge Handshake Authentication Protocol)** configuration files are used to authenticate peers. Use these scripts to alter the `pap-secrets` and `chap-secrets` files. These will only be required if you have set the options file to authenticate connections.

Note that you must save changes and reboot before any modifications will take effect.

PPP Answer

Choose PPP Answer and click **Configure**. The PPP Answer configuration page consists of four script files. The **Options configuration** file includes system default information such as baud rate, modem connection, flow control, peer authorization and IP addresses (local and remote) assigned to the port. See the Linux manual page `pppd` (`# man pppd`) for a full list of options. The **Chat configuration** file defines the dialog that occurs between client and server during connection. See the Linux manual page `chat` (`# man chat`) for a full list of options. The **PAP (Password Authentication Protocol)** and **CHAP (Challenge Handshake Authentication Protocol)** configuration files are used to authenticate peers. Use these scripts to alter the `pap-secrets` and `chap-secrets` files. These will only be required if you have set the options file to authenticate connections.

Signed In: wcm@192.168.42.3 [Help](#) [Sign Out](#)

Your Blue Heat/Net IP: 192.168.42.1 **Blue Heat/Net** [Save To Flash](#)

Home
 This section allows you to configure the files that answer and define a point-to-point connection.

Configure
 The options file provides options to pppd. "# man pppd" on a Linux machine will describe the available options.
 The chat file provides the connection script. "# man chat" on a Linux machine will describe the format and operation of the script.
 chap-secrets stores the username and password information for the CHAP protocol.
 pap-secrets stores the username and password information for the PAP protocol.
 The secrets files are only used if the appropriate authorization protocol has been configured in the options file.

Options configuration file

```
19200
modem
ispname
auth
look
192.168.0.254:192.168.0.1
```

Chat configuration file

```
#!/bin/sh
chat -v -e
ABORT      BUSY
ABORT      'NO CARRIER'
''         ATZ
OK         ATDT
OK         ''
TIMEOUT    31536000
```

PAP configuration file

```
# secrets for authentication using PAP
# client      server secret IP addresses
test         *      test  *
```

CHAP configuration file

```
# secrets for authentication using CHAP
# client      server secret IP addresses
test         *      test  *
```

Figure 11: PPP Answer Configuration

Raw TCP Server and Client Options

Blue Heat/Net serial ports can be configured to transmit/receive data using standard TCP. You can configure the port to behave as a server, allowing a remote device to make a TCP socket connection; or a client, enabling the Blue Heat/Net to initiate TCP-based contact with a remote device.

Raw TCP Server

When configured to use the Raw TCP Server personality, the Blue Heat/Net will use a TCP port to listen for an incoming connection via TCP from a remote computer or device. Once a connection is established, any data sent to the Blue Heat/Net through the TCP/IP connection is transmitted on the appropriate serial port. Any data received by the serial port is sent through the TCP/IP connection to the remote computer or device.

To configure your Blue Heat/Net serial port to behave as a TCP server, choose the personality option **Raw TCP Server** and click **Configure**. The Raw TCP Server page requires you specify the TCP Port used for incoming connections. Specify the **TCP Port** number in the input box and click **Submit**. (The server needs a unique TCP Port number for each serial port.) You will be prompted to **Save to Flash**. Reboot the Blue Heat/Net.

The screenshot shows the Blue Heat/Net web interface. At the top, it says "Signed In: wcm@192.168.42.3" and has "Help" and "Sign Out" links. The main header displays "Blue Heat/Net" with a logo and a "Save To Flash" button. The left sidebar contains navigation links for Home, Configure (Basic Serial Settings, Advanced Serial Settings, Security Settings, Blue Heat/Net Settings, Change Your Password, Firmware, Reboot, Restore Defaults), Monitor (Serial Port Traffic, Network Traffic, TCP/IP Statistics, My Blue Heat/Net), and Help (FAQ, Documentation, Contact Us). The main content area has two paragraphs of text explaining the Raw TCP Server configuration. Below the text is a form with a "TCP Port:" label, an input field containing "0", and a "Submit" button.

Figure 12: Raw TCP Server configuration

Raw TCP Client

When configured to use the Raw TCP Client, the Blue Heat/Net will use the specified IP address and TCP port to connect to a remote computer or device. The Blue Heat/Net will continue to attempt a connection every 3 seconds until one is established. Once connected, any data sent to the Blue Heat/Net through the TCP/IP is transmitted on the appropriate serial port. Any data received by the appropriate serial port is sent through the TCP/IP connection to the remote computer or device.

To configure the Blue Heat/Net serial port to behave as a TCP client, choose the personality option **Raw TCP Client** and click **Configure**. The Raw TCP Client page requires you specify the **IP Address** to which the Blue Heat/Net will try to connect. The IP address can be specified in the input box in the format 1.2.3.4 or as a DNS name (www.connecttech.com, for example). Specify

the TCP Port number and click **Submit**. You will be prompted to Save to Flash. Reboot the Blue Heat/Net.

The screenshot shows the Blue Heat/Net web interface. At the top, it displays 'Signed In: wcm@192.168.42.3' and navigation links for 'Help' and 'Sign Out'. The main header includes the Blue Heat/Net logo and a 'Save To Flash' button. The left sidebar contains a navigation menu with sections for 'Home', 'Configure', 'Monitor', and 'Help'. The 'Configure' section is expanded, showing options like 'Basic Serial Settings', 'Advanced Serial Settings', 'Security Settings', 'Blue Heat/Net Settings', 'Change Your Password', 'Firmware', 'Reboot', and 'Restore Defaults'. The 'Monitor' section includes 'Serial Port Traffic', 'Network Traffic', 'TCP/IP Statistics', and 'My Blue Heat/Net'. The 'Help' section includes 'FAQ', 'Documentation', and 'Contact Us'. The main content area is titled 'Raw TCP Client configuration' and contains two paragraphs of text explaining the configuration process. Below the text is a form with two input fields: 'IP Address: 127.0.0.1' and 'TCP Port: 4000', and a 'Submit' button.

Figure 13: Raw TCP Client configuration

Checking your Raw TCP/IP settings on the Blue Heat/Net

You can check your Raw TCP Client and/or Server settings once you have completed configuration through the WCM. To do so, open a Telnet session with your Blue Heat/Net and type **ps** at the command prompt. This will display a list of programs currently running.

Raw TCP Server listing

You should see information similar to the following: `<numbers> raw_pdata 2 _ 0`

In this case, the 2 refers to serial port 2, the 0 refers to the fact that the server is using the Blue Heat/Net default port for that serial port (49157 for serial port 2).

By contrast: `<numbers> raw_pdata 3 _ 4000` uses serial port 3 and listening for a TCP connection on port 4000.

Raw TCP Client listing

You should see information similar to the following:

`<numbers> raw_pdata 4 www.connecttech.com 80`

In this case, the 4 refers to serial port 4. It's connecting to www.connecttech.com on port 80.

Connecting Two Blue Heat/Nets together using standard TCP

You can directly connect two Blue Heat/Net devices by configuring a serial port on one to Raw TCP Server, and a serial port on the second to Raw TCP Client. Serial data received by one Blue Heat/Net can then be sent through a network or the internet to the second Blue Heat/Net's serial port. The serial ports operate independently of each other, and can be configured individually for baud rate and electrical interface.

Configure a serial port on one Blue Heat/Net in Raw TCP Server mode (see above) and note your TCP settings (the Blue Heat/Net's IP address and the TCP Port you provided.)

Configure a serial port on the second Blue Heat/Net in Raw TCP Client mode (see above) and input the settings used for the Raw TCP Server mode.

Reboot both Blue Heat/Nets. You should be able to exchange data between the two serial ports, regardless of the serial port settings on either unit. This will extend the range of the serial devices to anywhere that can be connected via TCP/IP, including the internet.

If you experience connection problems:

- Make sure the cables are connected properly.
- Check the settings on your Blue Heat/Net through the WCM. Make sure you're using the same port number for both the server and client.
- Start a Telnet session with the Blue Heat/Net in client mode. Use the ping utility on the client Blue Heat/Net to ping the server Blue Heat/Net. If ping is unsuccessful, then there are network issues that need to be resolved (or the server Blue Heat/Net is not plugged in). If ping is successful, recheck your client and server settings.
- If you can Telnet into the Blue Heat/Net, log in and type in `cat /var/log/syslog`. If the TCP Server is failing you'll see error log entries that may help in diagnosing the problem.

Testing Blue Heat/Net Raw TCP Client Mode with a Telnet Daemon

Testing Raw TCP Client Mode

Select **Configure basic serial settings** in the WCM. Choose a baud rate and serial port settings as appropriate.

Set the personality option to **Raw TCP Client** and click **Configure**. Input the computer name or IP Address of the computer you wish to reach. For TCP Port, choose the TCP port number to which you will connect. For Telnet sessions this is typically port number 23. Click **Submit**.

Select **Configure Basic serial settings** on the navigation menu. Click **Submit**, followed by **Save to Flash**. This registers the changes to the basic serial port as well as the change to the Raw TCP Client personality.

Select **Reboot** from the navigation menu. This will restart the Blue Heat/Net and launch the Raw TCP Client personality on your selected port. The Blue Heat/Net will attempt to connect and start a Telnet session. You should see a login prompt on your serial terminal screen.

If you do not see the login prompt:

- Make sure the serial cables are connected properly. For a direct serial connection to a PC, you'll typically need a null modem cable.
- Check the settings on your Blue Heat/Net through the WCM. Make sure everything is input correctly and that you have the correct port number.
- Start a Telnet session with the Blue Heat/Net. Log in and type `cat /var/log/syslog`. If the TCP connection is failing you'll see entries such as:
Tue Nov 30 00:01:01 raw_pdata[100]: Connect failed, closing socket
Tue Nov 30 00:01:01 raw_pdata[100]: client connect failed yourIPAddress:23

If you receive these messages, the Blue Heat/Net is not able to connect to the destination. Check to make sure that the other computer is up and running and that a Telnet daemon is currently operating.

Testing Raw TCP Server Mode

Select **Configure basic serial settings** in the WCM. Choose a baud rate and serial port settings as appropriate. Set the personality option to **Raw TCP Server** and click **Configure**.

Input the TCP Port you will use to listen for incoming connections. Do not select TCP port 23 as it is used by the Telnet daemon on the Blue Heat/Net. Click **Submit**.

Select **Configure basic serial settings** on the navigation menu. Click **Submit**, followed by **Save to Flash**. This registers the changes to the basic serial port as well as the change to the Raw TCP Server personality.

Select **Reboot** from the navigation menu. This will restart the Blue Heat/Net and launch the Raw TCP Server personality on your selected port. Select the specified port with your Telnet software to exchange data between the Telnet client and the serial port.

If you receive a login prompt, your Telnet session could be pointing to the Blue Heat/Net itself (port 23) and you need to exit the Telnet session and try again, this time specifying the port number you typed into the Raw TCP Server screen above.

If you experience connection problems:

- Make sure the cables are connected properly.
- Check the settings on your Blue Heat/Net through the WCM. Make sure you're using the port number specified in the Server setting with your Telnet client.
- Try connecting the Telnet client to port 23 on the Blue Heat/Net. If you can't get to the login prompt, you need to resolve network connection issues. There is configuration information in the Blue Heat/Net setup. Ping the IP address of the Blue Heat/Net.
- If you can Telnet into the Blue Heat/Net, log in and type in "cat /var/log/syslog". If the TCP Server is failing you'll see error log entries.

Configure Advanced Serial Settings

The Web Configuration Manager also allows you to configure more advanced serial port properties. These advanced properties will allow you to configure the XOn Character, XOff Character, Break Character, Escape Character, Error Character and Event Character, and Transmit Load Setting for each serial port.

Further, you will be able to specify whether you want to enable Null Stripping, RTS Toggle and FIFOs for a particular port as well as the option to enable or disable the Break, Event and Error characters.

By default, all advanced serial properties are disabled, with the exception of FIFO, which is enabled by default. You should only use these advanced properties if you require them.

You are required to use the ASCII representation of characters using the respective hexadecimal values. For example, if you wanted your XOn character to be capital 'A', you would specify a hex value of 41.

We have provided you with an ASCII table on the Advanced Serial Port Properties page for your convenience. Click on the [ASCII Table](#) link, and an ASCII table will open in a new window.

Each serial port parameter has been abbreviated due to space constraints. We have provided another link which describes the abbreviated parameter descriptions. Click on the [Parameter Descriptions](#) link, and a new window will open which contains a description of each parameter.

Signed In: wcm@192.168.42.3 Help Sign Out

Your Blue Heat/Net IP: 192.168.42.1 Save To Flash

Blue Heat/Net

This section allows you to configure advanced serial port properties for your Blue Heat/Net. Note that you must use hexadecimal representations of characters, and an ASCII table is provided for your convenience below. The TXL setting is used to limit the number of characters placed into the transmit FIFO. This TXL value is a decimal number between 1 and 128 characters.

[ASCII Codes](#) [Parameter Descriptions](#)

Port	XOn	XOff	EVE	EVT	ERE	ERR	BKE	BRK	ESC	NSE	RTS	TXL	FIFO
1	11	13	<input type="checkbox"/>	<input type="checkbox"/>	<input type="checkbox"/>	<input type="checkbox"/>	<input type="checkbox"/>	<input type="checkbox"/>	<input type="checkbox"/>	<input type="checkbox"/>	<input type="checkbox"/>	128	<input checked="" type="checkbox"/>
2	11	13	<input type="checkbox"/>	<input type="checkbox"/>	<input type="checkbox"/>	<input type="checkbox"/>	<input type="checkbox"/>	<input type="checkbox"/>	<input type="checkbox"/>	<input type="checkbox"/>	<input type="checkbox"/>	128	<input checked="" type="checkbox"/>
3	11	13	<input type="checkbox"/>	<input type="checkbox"/>	<input type="checkbox"/>	<input type="checkbox"/>	<input type="checkbox"/>	<input type="checkbox"/>	<input type="checkbox"/>	<input type="checkbox"/>	<input type="checkbox"/>	128	<input checked="" type="checkbox"/>
4	11	13	<input type="checkbox"/>	<input type="checkbox"/>	<input type="checkbox"/>	<input type="checkbox"/>	<input type="checkbox"/>	<input type="checkbox"/>	<input type="checkbox"/>	<input type="checkbox"/>	<input type="checkbox"/>	128	<input checked="" type="checkbox"/>
5	11	13	<input type="checkbox"/>	<input type="checkbox"/>	<input type="checkbox"/>	<input type="checkbox"/>	<input type="checkbox"/>	<input type="checkbox"/>	<input type="checkbox"/>	<input type="checkbox"/>	<input type="checkbox"/>	128	<input checked="" type="checkbox"/>
6	11	13	<input type="checkbox"/>	<input type="checkbox"/>	<input type="checkbox"/>	<input type="checkbox"/>	<input type="checkbox"/>	<input type="checkbox"/>	<input type="checkbox"/>	<input type="checkbox"/>	<input type="checkbox"/>	128	<input checked="" type="checkbox"/>
7	11	13	<input type="checkbox"/>	<input type="checkbox"/>	<input type="checkbox"/>	<input type="checkbox"/>	<input type="checkbox"/>	<input type="checkbox"/>	<input type="checkbox"/>	<input type="checkbox"/>	<input type="checkbox"/>	128	<input checked="" type="checkbox"/>
8	11	13	<input type="checkbox"/>	<input type="checkbox"/>	<input type="checkbox"/>	<input type="checkbox"/>	<input type="checkbox"/>	<input type="checkbox"/>	<input type="checkbox"/>	<input type="checkbox"/>	<input type="checkbox"/>	64	<input checked="" type="checkbox"/>

Figure 14: Configuring Advanced Serial Port Properties

Configure Security Settings

The security configuration option will allow you to specify which IP addresses can access your Blue Heat/Net serial ports.

For each of your Blue Heat/Net serial ports, you have three security options:

- Any IP Addresses: This option will allow any IP address to access your Blue Heat/Net Serial port. This is the default security setting for each Blue Heat/Net port.
- No IP Addresses: This option will deny any IP address from accessing your Blue Heat/Net serial port.
- This list of IP Addresses: This option will allow a given set of IP addresses to access a Blue Heat/Net serial port. Simply type in the list of IP addresses in the Text Field provided. Current Blue Heat/Net models do not allow you to specify a range of IP addresses (i.e. 113.334.334.* is not allowed), or hostnames.

Once you have configured your Security Settings, click the **Submit** button at the bottom of the page. A confirmation page will appear.

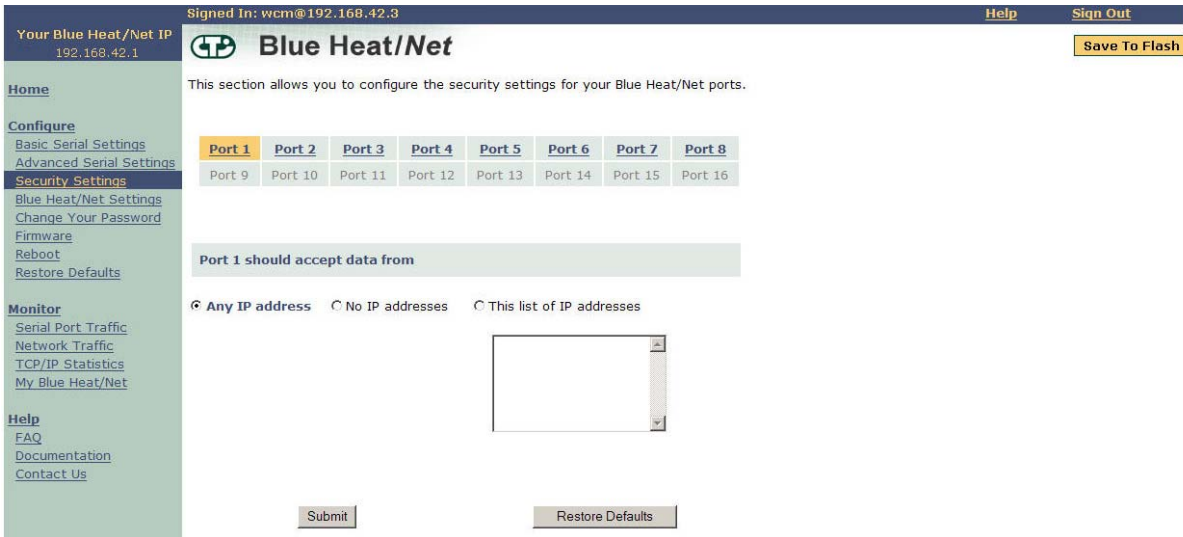

Figure 15: Configuring Security Settings

Configure Blue Heat/Net Settings

This section provides various Blue Heat/Net Configuration options, and shows you the saved versus current settings. The details for each configuration option are provided below:

- **Flash Enabled:** This option enables or disables the ability of the Blue Heat/Net to boot-up from Flash memory.
- **Bootp Enabled:** This option enables or disables the Blue Heat/Net's ability to obtain boot-up information from the server (see "Server IP Address" below).
- **TFTP Enabled:** This option enables or disables the ability to download and boot from a file located on a server (see "Server IP Address" below).
- **DHCP Enabled:** This option enables or disables the use of DHCP. If DHCP is enabled, the Blue Heat/Net will attempt to automatically obtain an IP address. If DHCP is disabled, you must manually specify an IP address for the Blue Heat/Net.
- **Configuration Port:** This option sets the port to scan for the password to gain entry into the Serial Configuration Manager. You can specify a particular port, or specify the **Scan All Ports** option. In this case the Blue Heat/Net will scan all ports for the password when the Blue Heat/Net is booting. The default setting is **Scan All Ports**.
- **Session Timeout:** This option specifies the time allowed between web page navigation. The default session timeout is 5 minutes. This means if the Web Configuration Manager has not received any requests for more than 5 minutes, you will be automatically logged out. You can set the timeout from 1 minute to 2 hours, or disable the session timeout all together by selecting the **Disable Timeout** option.
- **Boot Delay:** This option specifies time allowed for gaining access to the Serial Configuration Manager while the Blue Heat/Net is booting. The time ranges from 2 seconds to 30 seconds. The default setting is 30 seconds.
- **Server IP Address:** This option sets the server IP address. This is used as the Server address to use when bootp mode or TFTP mode is enabled. The default Server IP address is 0.0.0.0
- **Blue Heat/Net IP Address:** This option sets the IP address of your Blue Heat/Net. The default IP address for your Blue Heat/Net is 192.168.42.1

- **Domain Name:** This option sets the domain name of your Blue Heat/Net. The default domain name is `blueheat.net`.
- **Host Name:** This option sets the hostname of your Blue Heat/Net. The default hostname is `BHNsssss`, where `sssss` is your Blue Heat/Net serial number.
- **Gateway IP Address:** This option sets the Gateway IP address for your Blue Heat/Net. The default Gateway IP address is `0.0.0.0`
- **Broadcast IP Address:** This option sets the Broadcast IP address. The default Broadcast IP address is `255.255.255.255`.
- **Subnet Mask:** This option sets the Subnet mask IP address. The default Subnet mask IP address is `255.255.255.0`.
- **Bootfile Name:** This option specifies the default file name which will be used for Blue Heat/Net boot-up, *if TFTP is enabled*. If TFTP is enabled, the Blue Heat/Net will attempt to download the bootfile you specify from a Server IP address you specify (see "Server IP Address" above). The bootfile name should reference a valid uClinux kernel image. If TFTP is enabled, the Blue Heat/Net unit will attempt to download this image, and will also attempt to decompress the image and run it.
- **TCP Port:** This option allows you to change the starting local TCP port that is used to service clients connecting to the Blue Heat/Net unit. The default TCP port is 49152. When altering the TCP port on the Blue Heat/Net unit, you must also alter it on the user's side.
- **Domain Server IP Address:** This option sets the Domain Name Server IP address. The default DNS IP address is `0.0.0.0`.

After you've made any necessary configuration changes, click the **Submit** button at the bottom of the page. A confirmation page will show up confirming the Blue Heat/Net changes.

Signed In: wcm@192.168.42.3 [Help](#) [Sign Out](#)

Your Blue Heat/Net IP: 192.168.42.1 [Save To Flash](#)

Blue Heat/Net

This section allows you to configure Blue Heat/Net system properties. The [help](#) section describes each configuration parameter in detail.

Boot Mode Settings

Flash Enabled Yes No
 Bootp Enabled Yes No
 tftp Enabled Yes No
 Use DHCP Yes No

Blue Heat/Net Settings	Saved Settings	Current Settings
Configuration Port	Scan All Ports	
Session Timeout	5 minutes	
Boot Delay	30 seconds	
Server IP Address	0.0.0.0	
Blue Heat/Net IP Address	192.168.42.1	
Apply On Sign Out	<input type="radio"/> Yes <input checked="" type="radio"/> No	192.168.42.3
Domain Name	blueheat.net	blueheat.net
Hostname	BHN00001140	BHN00001140
Gateway IP Address	0.0.0.0	0.0.0.0
Broadcast IP Address	255.255.255.255	255.255.255.255
Subnet Mask	255.255.255.0	255.255.255.0
Bootfile Name	BHNuClinux_1.09.gz	
TCP Port	49152	
DNS IP	0.0.0.0	0.0.0.0

[Submit](#) [Restore Defaults](#)

Figure 16: Configuring Blue Heat/Net Settings

Configure Firmware

This section enables you to download new firmware to the Blue Heat/Net unit. Select a download source and a specific firmware file path, if applicable, and then submit the download

request. This section also provides a link to reboot your Blue Heat/Net. This is standard procedure after installing new firmware.

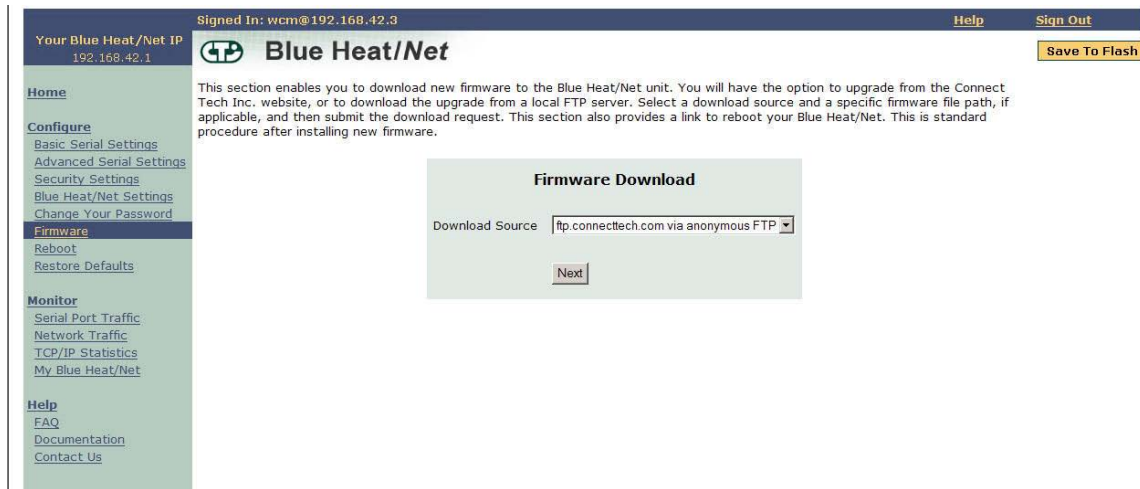

Figure 17: Firmware Upgrades/Downloads

Restore Defaults

The Restore Defaults page enables you to quickly reset all or some of the default basic, advanced, security, Blue Heat/Net or system settings of your Blue Heat/Net.

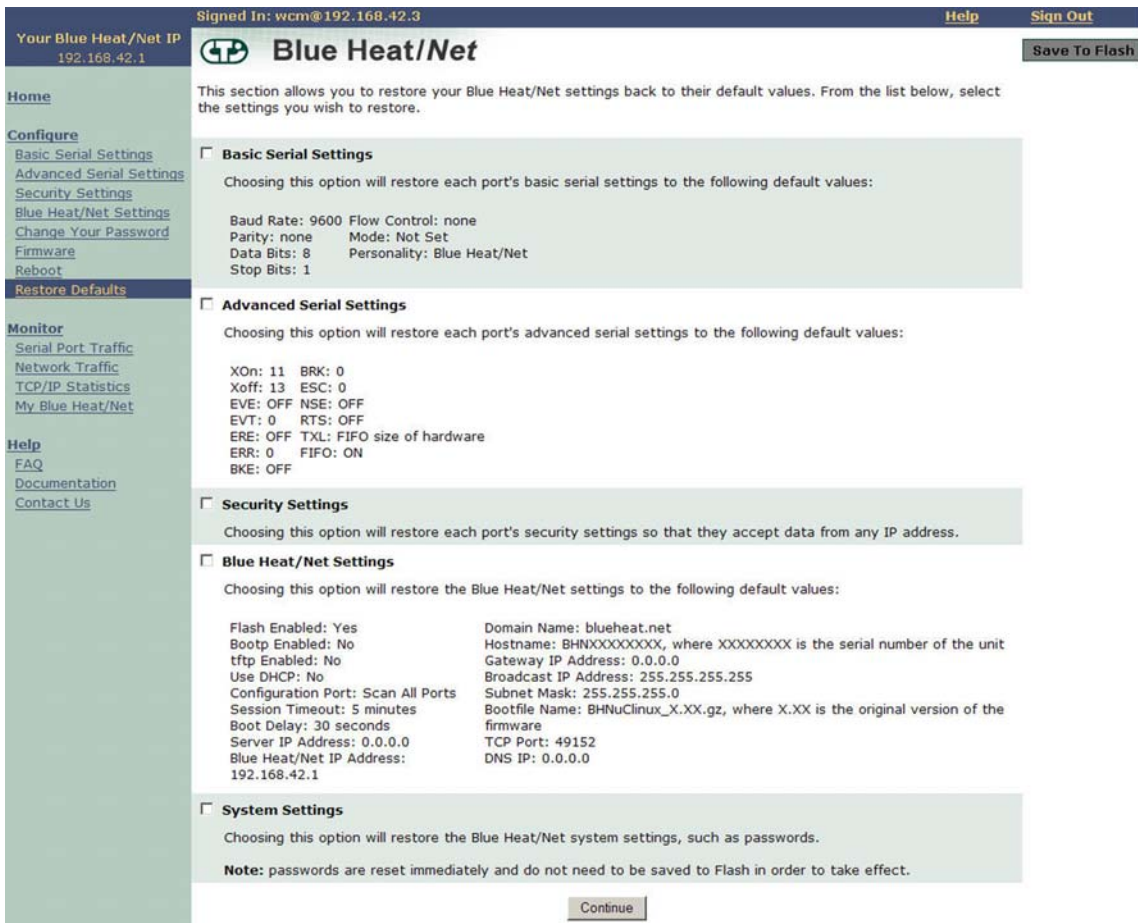

Figure 18: Restore Default Settings

Saving To Flash

When you make configuration changes, the changes are stored temporarily in memory. If you reboot your Blue Heat/Net at this point, any configuration changes you made will be lost. To permanently save your changes, you need to save them to Flash. In order to do this, click the **Save to Flash** button on the upper right-hand side of the Web Configuration Manager page. If there are changes that need to be saved, the **Save To Flash** button will be yellow. Click the **Submit** button to permanently save any configuration changes to the Flash Memory so they will be present when you reboot your Blue Heat/Net.

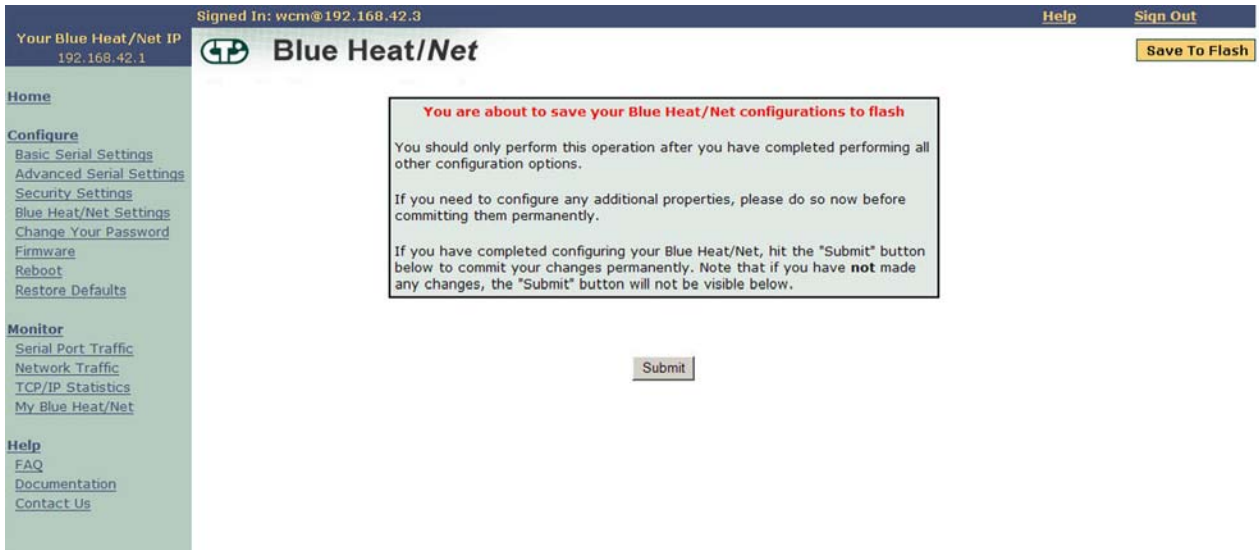

Figure 19: Saving To Flash

If you haven't made any configuration changes, the **Save To Flash** button will remain grey.

Monitoring Your Blue Heat/Net

The Blue Heat/Net WCM lets you monitor serial port activity, network traffic and TCP/IP statistics as well as providing hardware and software details for your Blue Heat/Net unit.

Monitor Serial Port Traffic

This page allows you to monitor your serial port traffic. For each Blue Heat/Net port, you can view the number of bytes transmitted, received, whether the port is using flow control, if there are any Parity/Framing/Overrun errors, and which remote IP address is connected to your serial port.

If ports are active (open) they are shown in green, while inactive (closed) ports are shown in grey.

Signed In: wcm@192.168.42.3 Help Sign Out

Your Blue Heat/Net IP: 192.168.42.1 Save To Flash

Blue Heat/Net

This section allows you to monitor your serial port traffic. Active (open) ports are shown in green; inactive (closed) ports are shown in grey. For more information, please refer to the [help](#) section.

Port	Tx Bytes	Rx Bytes	Remote IP	Flow Control	PFO Errors
Port 1	0	0	Port Closed	none	0
Port 2	0	0	Port Closed	none	0
Port 3	0	0	Port Closed	none	0
Port 4	0	0	Port Closed	none	0
Port 5	0	0	Port Closed	none	0
Port 6	0	0	Port Closed	none	0
Port 7	0	0	Port Closed	none	0
Port 8	0	0	Port Closed	none	0

Configure

- Basic Serial Settings
- Advanced Serial Settings
- Security Settings
- Blue Heat/Net Settings
- Change Your Password
- Firmware
- Reboot
- Restore Defaults

Monitor

- Serial Port Traffic**
- Network Traffic
- TCP/IP Statistics
- My Blue Heat/Net

Help

- FAQ
- Documentation
- Contact Us

Figure 20: Monitoring Serial Port Activity

Monitor Network Traffic

This page allows you to view all network activity on your Blue Heat/Net. For each active network connection, you can view the local IP address and port, the remote IP address and port, the status of the connection, the protocol being used, as well as the number of queued transmit and receive bytes.

Signed In: wcm@192.168.42.3 Help Sign Out

Your Blue Heat/Net IP: 192.168.42.1 **Save To Flash**

Blue Heat/Net

This section allows you to monitor your current Blue Heat/Net network traffic. Only active connections are shown.

Basic View Detailed View

Host IP : Port	Remote IP : Port	Rx Bytes	Tx Bytes
206.130.75.204:80	206.130.75.65:2215	0	0
206.130.75.204:80	206.130.75.65:2220	0	0
206.130.75.204:80	206.130.75.65:2218	0	0

Configure
[Basic Serial Settings](#)
[Advanced Serial Settings](#)
[Security Settings](#)
[Blue Heat/Net Settings](#)
[Change Your Password](#)
[Firmware](#)
[Reboot](#)
[Restore Defaults](#)

Monitor
[Serial Port Traffic](#)
[Network Traffic](#)
[TCP/IP Statistics](#)
[My Blue Heat/Net](#)

Help
[FAQ](#)
[Documentation](#)
[Contact Us](#)

Figure 21: Monitoring Network Traffic

Monitor TCP/IP Statistics

This page allows you to view TCP, IP, UDP and ICMP statistics for your Blue Heat/Net. This page also has a link which describes each of the network statistic parameters. Simply click on the Parameter Descriptions link, and a new window will open up which contains a description of each parameter.

Signed In: wcm@192.168.42.3 Help Sign Out

Your Blue Heat/Net IP: 192.168.42.1 **Save To Flash**

Blue Heat/Net

This section allows you to monitor IP, TCP, UDP and ICMP statistics for the Blue Heat/Net. Simply click on the protocol you would like to view.

Parameter Descriptions

TCP Statistics IP Statistics UDP Statistics ICMP Statistics

RtoAlgorithm	0		
RtoMin	0		
RtoMax	0		
MaxConn	0		
ActiveOpens	0		
PassiveOpens	90		
AttemptFails	0		
EstabResets	0		
CurrEstab	1		
InSegs	1211		
OutSegs	1843		
RetransSegs	0		
InErrs	0		
OutRsts	0		

Configure
[Basic Serial Settings](#)
[Advanced Serial Settings](#)
[Security Settings](#)
[Blue Heat/Net Settings](#)
[Change Your Password](#)
[Firmware](#)
[Reboot](#)
[Restore Defaults](#)

Monitor
[Serial Port Traffic](#)
[Network Traffic](#)
[TCP/IP Statistics](#)
[My Blue Heat/Net](#)

Help
[FAQ](#)
[Documentation](#)
[Contact Us](#)

Figure 22: Monitoring TCP/IP Statistics

My Blue Heat/Net

This page provides you with three display options: Hardware, Software and Performance. Use this link to find information such as device serial number, runtime software versions and firmware versions.

The screenshot shows the 'My Blue Heat/Net' web interface. The top navigation bar includes 'Signed In: wcm@192.168.42.3', 'Help', and 'Sign Out'. The main content area is titled 'Blue Heat/Net' and contains a 'Save To Flash' button. Below the title, there are three tabs: 'Hardware Details', 'Software Details', and 'Performance'. The 'Hardware Details' tab is selected, displaying a table of hardware information.

Product Serial Number	00001140
Product MAC Address	00:0c:8b:00:04:74
Part Number	BN008
Description	Blue Heat/Net
Port 1 UART Type	864
Port 2 UART Type	864
Port 3 UART Type	864
Port 4 UART Type	864
Port 5 UART Type	864
Port 6 UART Type	864
Port 7 UART Type	864
Port 8 UART Type	864

Figure 23: My Blue Heat/Net Hardware Details

The screenshot shows the 'My Blue Heat/Net' web interface with the 'Software Details' tab selected. It displays a table of software versions for runtime software and firmware modules.

Versions for Runtime Software	
Blue Heat/Net	1.09
uClinux	20020927
linux kernel	2.4.19
serial driver	5.05.07
libcfg	2.23
libtwcm	1.5
plauncher	0.10
ctid	0.117
bhn	dbg
bhnconfig	0.83
calcnet	0.60
sink	2.60
talk	2.60
login	2.0
tcn	3.0
wcm	1.2
rawsock	0.001
sample_app	0.00
Versions for Firmware Modules	
Bootloader	V209
CDS	V14

Figure 24: My Blue Heat/Net Software Details

Software Installation for Windows

The Blue Heat/Net is designed for easy installation and set up. This section deals with installing and using the Blue Heat/Net software to communicate with your Blue Heat/Net and its COM ports.

To do so, you will use the CD included with the Blue Heat/Net to install the Configuration Manager on your computer. The Blue Heat/Net Configuration Manager will allow you install the Blue Heat/Net on your local system, and map and configure the Blue Heat/Net's communication ports.

Installing the Blue Heat/Net Configuration Manager

The Blue Heat/Net Configuration Manager is a tool to control your Blue Heat/Net from your local Windows operating system. To install the Blue Heat/Net Configuration Manager on your computer, insert the CD provided with your Blue Heat/Net into the disk drive.

You should see this window in your browser:



Figure 25: Blue Heat/Net Driver/Software Installation CD

NOTE: Windows XP SP2 users should read the SP2 info prior to installing the Configuration Manager

Select View from the Blue Heat/Net software. It will bring you to the following screen. Click **Install** to begin the Configuration Manager installation. Ensure you choose **Open** or **Run** when the File Download window appears and asks if you'd like to open the file or save it to your computer.

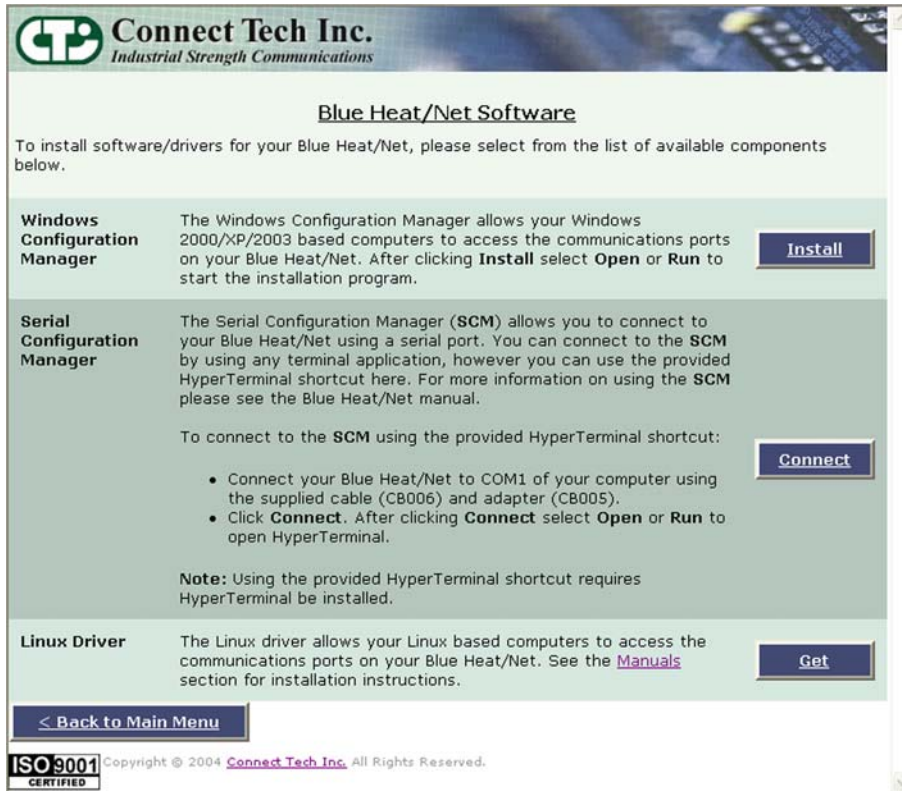
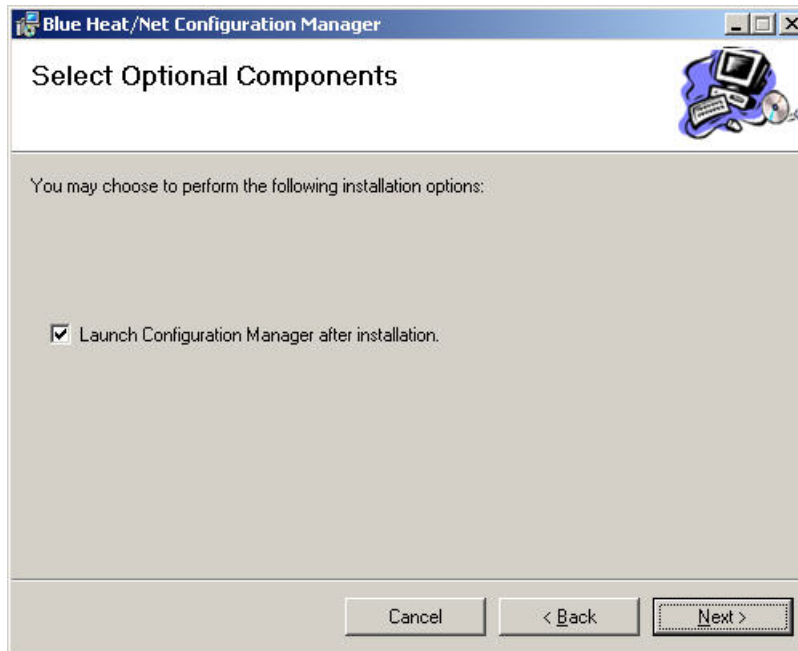

Figure 26: Blue Heat/Net Software Installation Screen

The Blue Heat/Net Configuration Manager Setup Wizard will begin. Click **Next** to start.



Next you will have the option to launch the configuration manager after installation.



The installer will install the Configuration Manager into C:\Program Files\CTI\Blue Heat Net. If you'd prefer an alternate location, specify in the space provided, or click Browse to locate the new folder. Click Next.

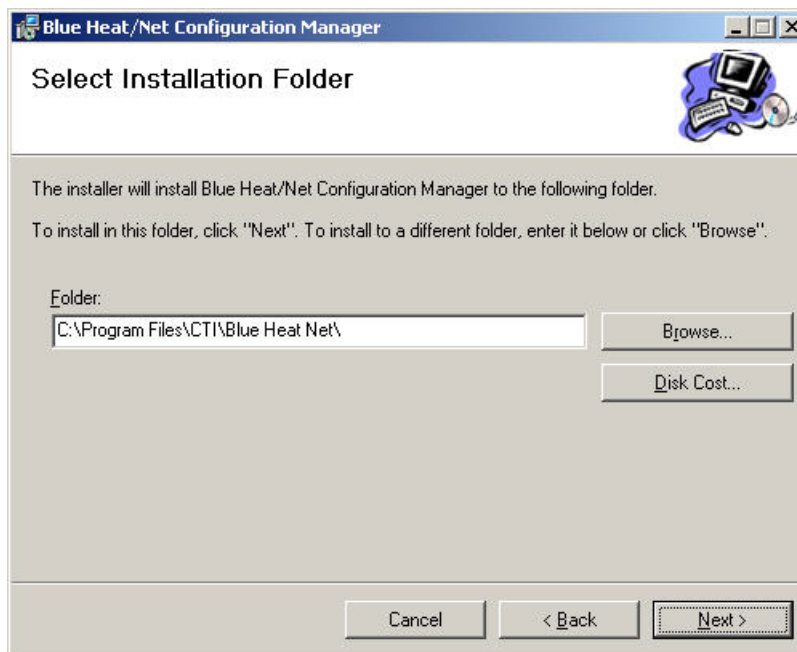

You will then be prompted to confirm you wish to install the Configuration Manager. Select Next to begin.

When the Installation Complete window appears, the Configuration Manager has been successfully installed. Click Close to exit the installation wizard.

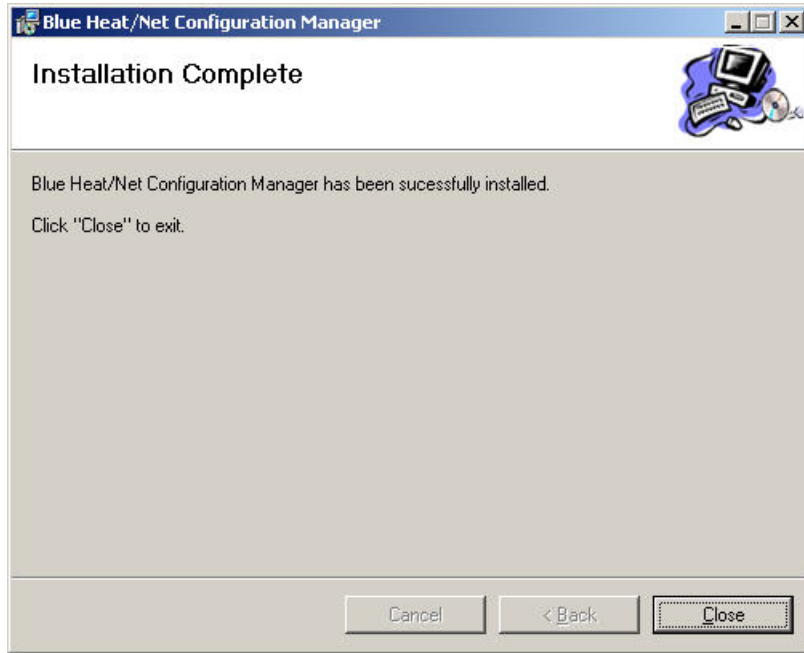

Figure 27: Blue Heat/Net Configuration Manager, Installation complete screen

Running the Configuration Manager

If you chose the option to launch the Blue Heat/Net Configuration Manager after installation, the main Configuration Manager window should now be open on your screen. If you did not, you can launch it from the CTI default folder or whichever folder you chose during the installation.

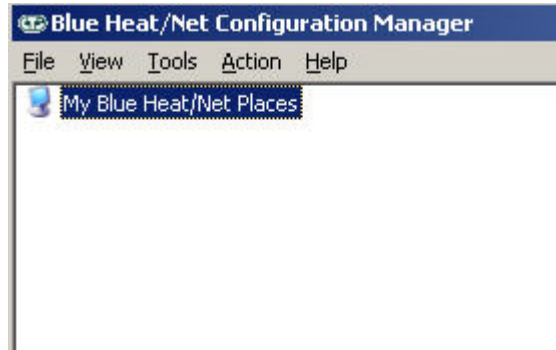
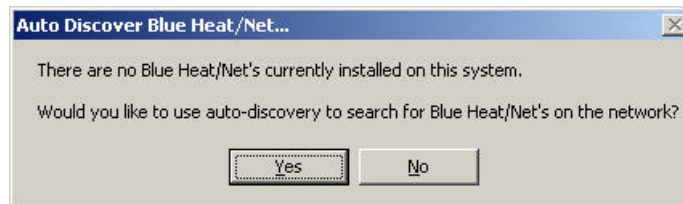

Figure 28: My Blue Heat/Net Places screen

Device Installation

Select My Blue Heat/Net Places from the main Configuration window. (NOTE: If there is no Blue Heat/Net installed, you will be prompted to auto discover a Blue Heat/Net on your network. If



you choose to do so, click Yes and then jump ahead to the [Auto Discover Blue Heat/Net](#) section) Right-click on My Blue Heat/Net Place or click on the Action menu to pull up the sub menu options.

There are three ways to install a Blue Heat/Net device: Configure Default Blue Heat/Net, Add New Blue Heat/Net or Auto Discover Blue Heat/Net.

Configure Default Blue Heat/Net

You can choose this option when your Blue Heat/Net still has a factory default IP address of 192.168.42.1. It will launch the Web Configuration Manager for this IP address, enabling you to configure your Blue Heat/Net as outlined in the [Web Configuration Manager](#) section.



Figure 29: Add or Auto Discover Blue Heat/Net menu screen

Add New Blue Heat/Net

You can add a Blue Heat/Net by specifying the Blue Heat/Net's IP address or MAC address.

If you specify an IP address, the Configuration Manager will connect to that specific Blue Heat/Net and the configuration information for installation. If it cannot connect, it will not install the unit. The Blue Heat/Net may get the IP address from DHCP server or it can be manually fixed. The Configuration Manager will use 49152 as the default TCP port. This value is configurable.

If you specify a MAC address (located on the underside of the device), the Configuration Manager will use the auto-discover mechanism to retrieve the information for installation. The auto-discover mechanism uses UDP broadcast, so the unit must be located on the local network to install via MAC address. The Configuration Manager will use 49152 as the default UDP port. This value is configurable.

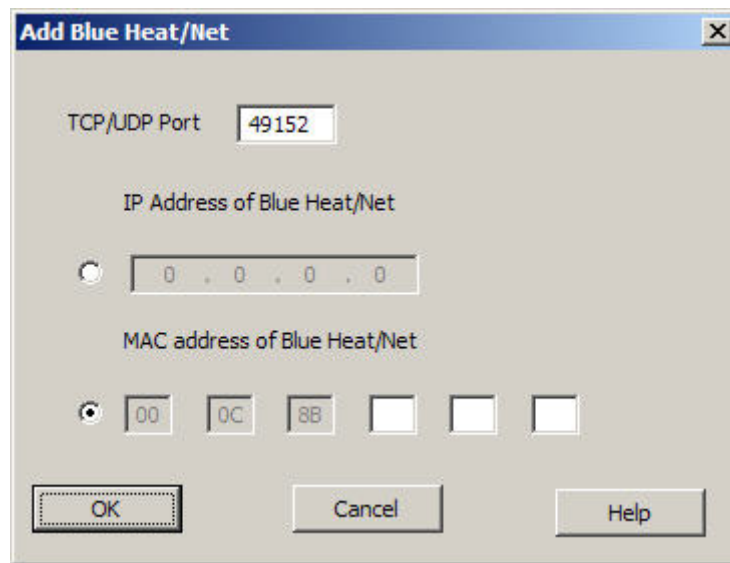

Figure 30: Add Blue Heat/Net screen

Auto Discover Blue Heat/Net

The auto discover will broadcast a message to all the Blue Heat/Net devices on your network. Upon receiving the broadcast packet, the Blue Heat/Net device will respond. Click the **Auto Discover** button to search for Blue Heat/Net. The searching domain can be changed by checking **Use Specific Broadcast IP** and entering an IP address domain in the IP address box. The broadcast packet will use the default UDP port 49152, but it can be changed in the Blue Heat/Net configuration. The **Stop** button will end the search.

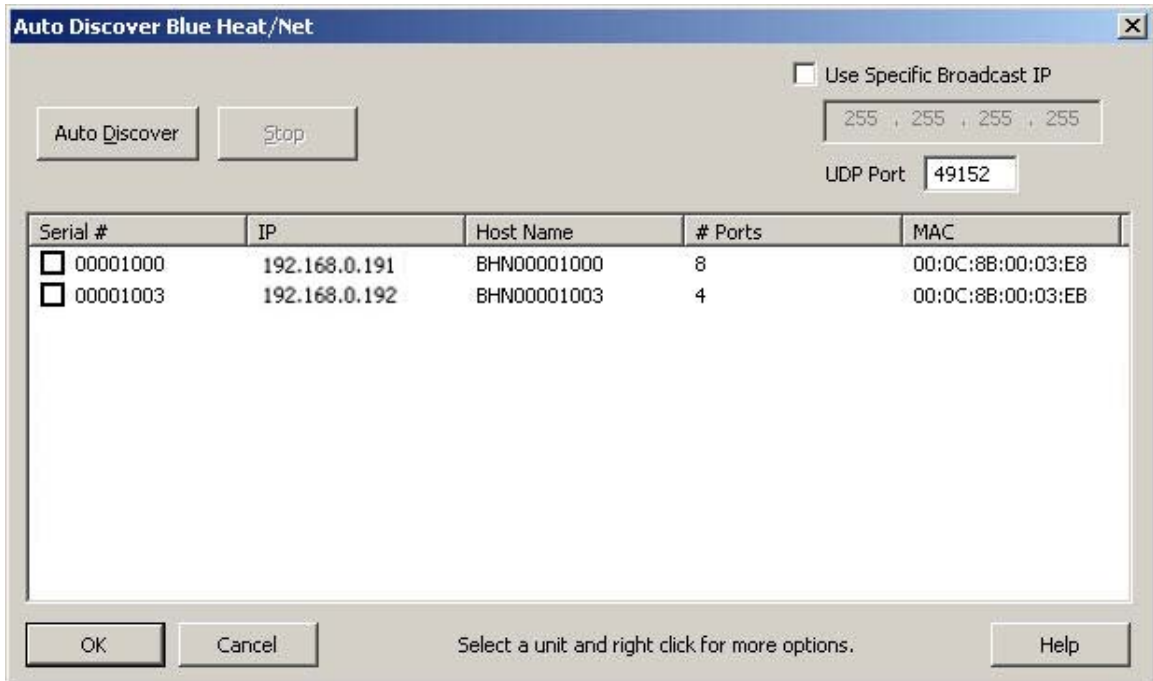

Figure 31: Auto Discover Blue Heat/Net screen

Auto Discover will list any Blue Heat/Nets on your network, along with Blue Heat/Net's Serial number, IP address, Host Name, Number of available ports and the MAC address. To install a Blue Heat/Net check the appropriate box under Serial # column and then click OK. Right click for more options, including the option to launch the Web Configuration Manager.

Configuring the Blue Heat/Net

After the unit is installed the Configuration window will look like this:
You are now ready to map the ports of the Blue Heat/Net.

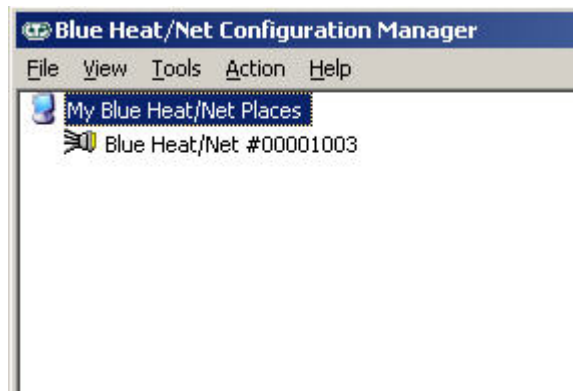

Figure 32: Installed Blue Heat/Net screen

Port Mapping

To map the available ports of the Blue Heat/Net (either eight or four, depending on your model), right-click on **Blue Heat/Net #** and then select **Map Port(s)**. You can also select **Action** from the main menu, and choose **Map Port(s)**.

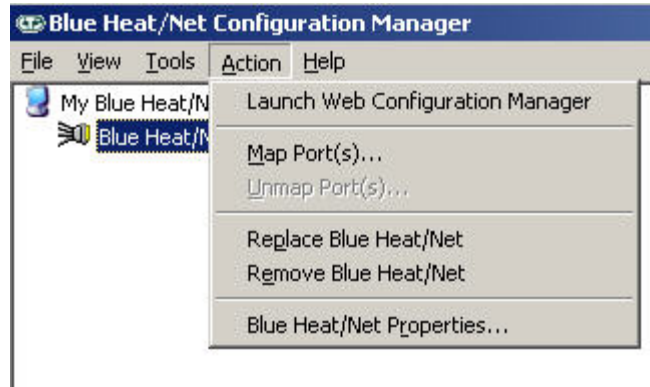

Figure 33: Map Port(s) menu

There are three modes to Map Ports: **Basic**, **Advanced** and **Express**.

Express

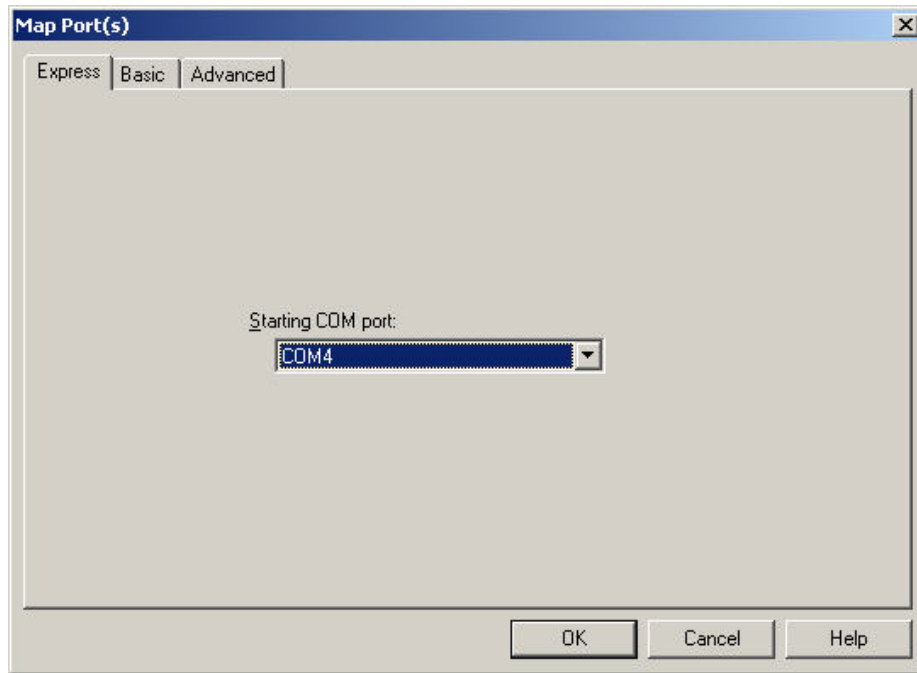

Figure 34: Map Port(s) Express method screen

This will install all the available ports of the selected Blue Heat/Net with one click. The list box **Starting COM Port** enables the user to select the starting COM number. If a COM number with in use is selected, ensure those ports are not attached to a device by going to My Computer -> Control Panel -> System -> Hardware -> Device Manager -> Ports (COM & LPT). During the course of port mapping, the **Found New Hardware Wizard** will appear as follows:



Figure 35: Found New Hardware Wizard

Select Install the software automatically. Click Next. If you are running Windows 2000 this wizard will not appear.

Upon successful installation, this window will appear:

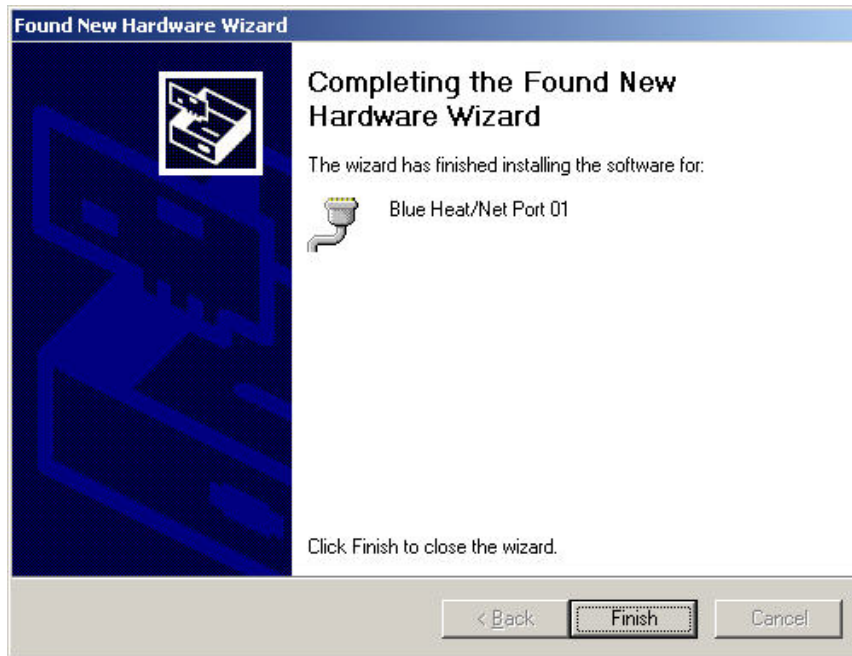

Click Finish.

If there are more ports to map, the Found New Hardware Wizard will appear again. Repeat the procedure above until all the ports are mapped.

The ports are now mapped, and the Configuration Manager window should appear similar to the one below.

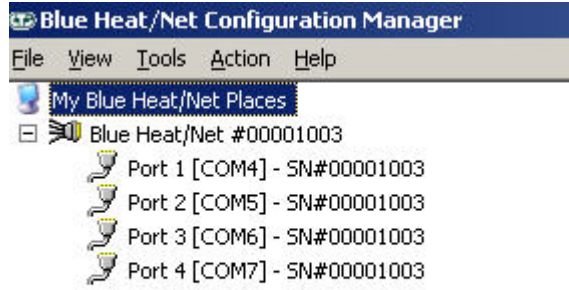

Figure 36: Configuration Manager Window after successfully mapping ports

Basic

The Basic option installs all the available ports of the selected Blue Heat/Net, one port at a time. It has two list boxes, Blue Heat/Net Port and Local COM Port.

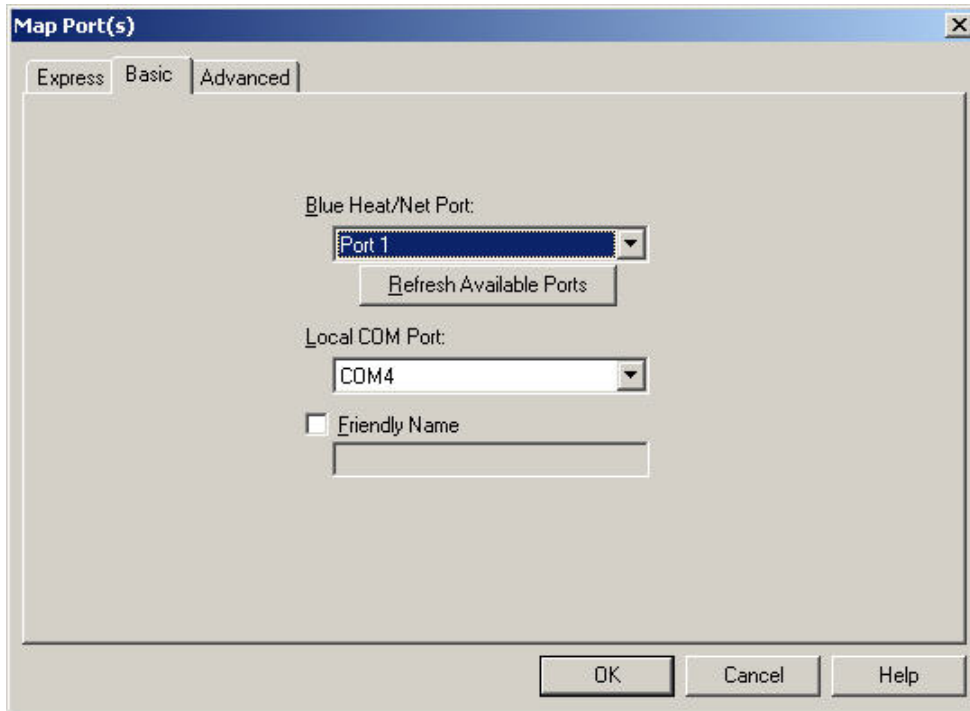

Figure 37: Basic Port Mapping option

Blue Heat/Net Port:

This refers to the physical COM port on the Blue Heat/Net as labelled on its enclosure. Click Refresh Available Ports to update this list to reflect the current status.

Local COM Port:

This is local COM number that the OS application will use. It is the virtual COM port equivalent of the remote COM port. It is also the starting COM number for the first remote port. If a COM number with 'in use' is selected then ensure those ports are not attached to a device by going to My Computer -> Control Panel -> System -> Hardware -> Device Manager -> Ports (COM & LPT).

Friendly Name:

You can choose to add a name to the port description. This is an optional feature that adds a personalized string to the description of the port in the main display window. Choose the appropriate Blue Heat/Net port and a corresponding local COM number in the list menus, and enter a Friendly Name, if desired, and click OK. The [Found New Hardware Wizard](#) will appear. See instructions above for remainder of setup process.

Advanced

Figure 38: Advanced port mapping interface

This is an advanced interface for mapping ports. It will show all remote ports available for mapping as follows:

It has three columns, Blue Heat/Net Port, Status and Local Port.

Blue Heat/Net Port refers to the physical port on Blue Heat/Net, Status refers to whether the port is mapped or not and Local Port refers to the possible COM numbers that the Win32 application will use. The above example shows that the selected Blue Heat/Net has two available ports to map, and that Ports 1 and 4 are already mapped.

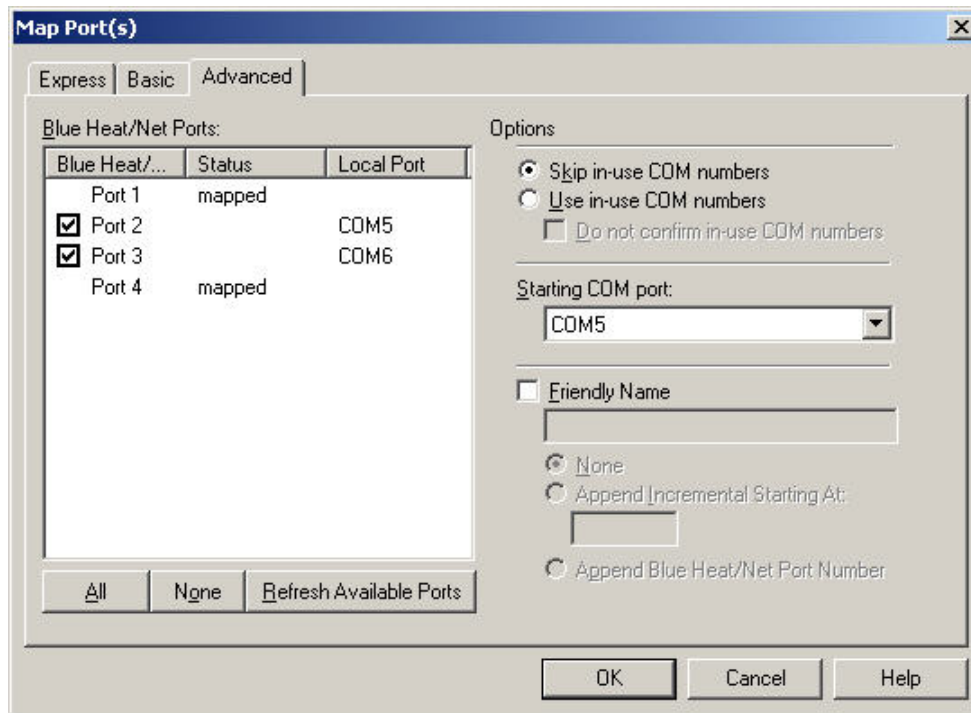
Click **None** to deselect all Blue Heat/Net Port selections and none will be mapped. An individual Remote Port can be mapped by marking the corresponding check box. Clicking **All** will select all Blue Heat/Net Ports for mapping. **Refresh Available Ports** will refresh this list.

The Advanced window offers the following choice under Options:

Skip in-use COM numbers

Use in-use COM numbers.

This is related to the local COM number for the mapped ports. Sometimes, COM numbers can be occupied in the operating system's COM number database even though they are not attached to any device. If **Skip in-use COM numbers** is selected during mapping, then those occupied COM numbers will be passed over and the next free COM number will be used. If **Use in-use COM numbers** is selected then those occupied COM numbers will be used, with a user warning, during mapping. If **Do not confirm in-use COM numbers** is checked then no warning will be issued. Be extra careful when selecting **Use in-use COM numbers** since it will conflict if any device is attached to that occupied COM number. To find out if a device is attached to that COM number go to My Computer -> Control Panel -> System -> Hardware -> Device Manager -> Ports (COM & LPT).

Starting COM port: This enables you to change the starting COM number for mapping. If a COM number with [in use] is selected, ensure those ports are not attached to any device by going to My Computer -> Control Panel -> System -> Hardware -> Device Manager -> Ports (COM & LPT).

Friendly Name is an optional feature that enables the user to edit a string to be appended to the port description of My Computer -> Control Panel -> System -> Hardware -> Device Manager -> Ports (COM & LPT). Selecting **Append Incremental Starting At:** will append the number entered for that edit box to the entered **Friendly Name** string, this number will be incremented for multiple port mappings checked in the **Blue Heat/Net Port** list. Selecting **Append Remote Port Number** will append the remote port number to the string entered in the edit box.

For each port installed, the [Found New Hardware Installation Wizard](#) will appear.

Unmap Port(s):

This option is located under the Action menu item when the Blue Heat/Net unit is selected, or an individual port is selected. . It is also available by right-clicking on the selected Blue Heat/Net unit or port.

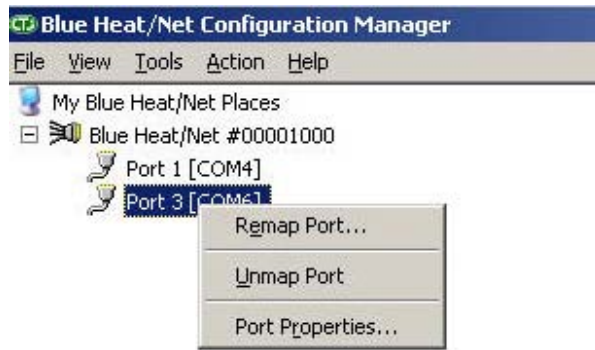

Figure 39: Port action menu

If you choose to unmap a local COM port while selecting a port, a dialogue box will prompt you to be sure you wish to unmap the port.

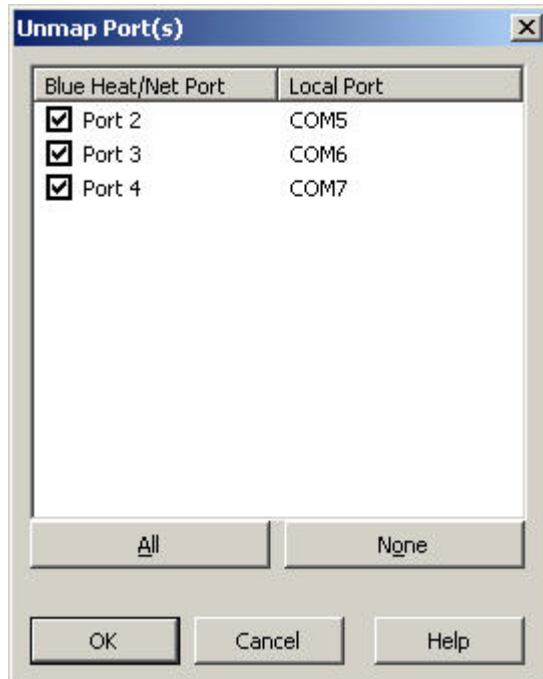

Figure 40: Unmap Port window

If you choose Unmap Port while the Blue Heat/Net unit is selected, you will see a list of ports. **Blue Heat/Net Port** refers to the port on the Blue Heat/Net and **Local Port** refers to the corresponding COM port on the computer for Win32 applications. **All** will select all ports of the selected unit to be unmapped, **None** will deselect all ports. Individual ports can be selected by checking the respective port under the **Blue Heat/Net Port** column.

Remapping Ports

Select the installed port you wish to remap, and then either go to the **Action** menu or right-click. Choose **Remap Port**. A dialogue box will display the current COM port, and ask you to input the new COM port from a drop down menu. Select the new COM port and click **OK**

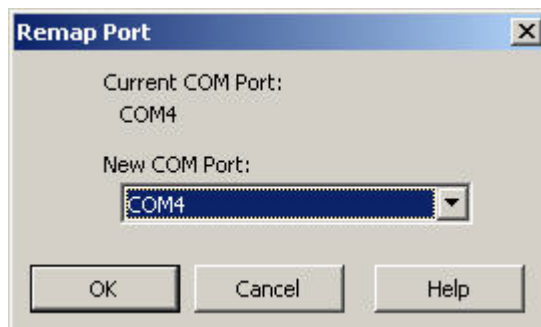

Figure 41: Remap Port window

Port Properties

Right-click on the port you wish to observe, and choose **Port Properties**. A window will open with three tabs: **General**, **Port Settings** and **Driver**.

The **General** properties include port and COM number, serial number, device type, manufacturer and location.

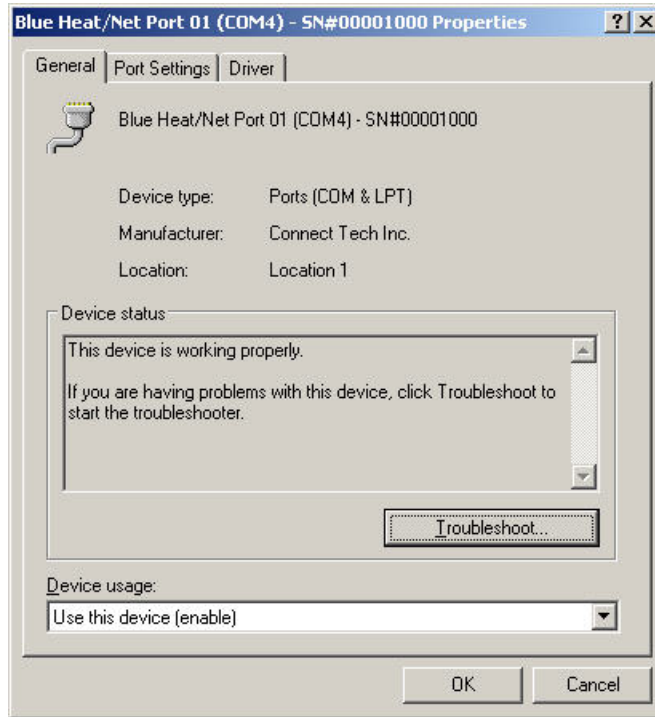

Figure 42: Port Properties window

The **Port Settings** tab gives the user access to the basic port setting options: Bits per second, Data bits, Parity, Stop bits and Flow control. There is also an option to reset all port settings to their default settings.

Advanced Settings

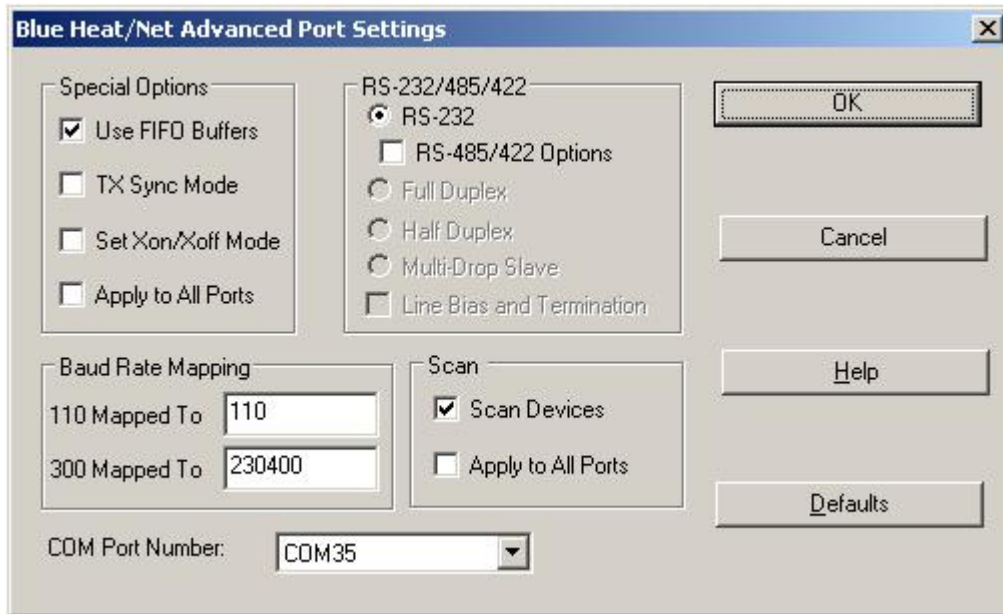

Figure 43: Advanced settings window

Special Options

With the exception of Use FIFO Buffers, these options are typically left unselected. They are provided to maintain compatibility with applications that require strict synchronization between the Blue Heat/Net and the application. Some degradation of throughput will occur when these options are selected.

- **Use FIFO Buffers** (default is selected)
The Blue Heat/Net makes use of UARTs with configurable FIFOs. Selecting or deselecting this option will enable or disable FIFO buffers of the UART respectively.
- **Tx Sync Mode** (default is unselected)
In this mode data will not be marked as sent until the Blue Heat/Net has actually sent the data. This allows for tight synchronization between the application and the data transmission. Data is reported as soon as it is sent to the Blue Heat/Net when this mode is **not** turned on. Leaving this mode unselected improves throughput.
- **Set Xon/Xoff Mode** (default is unselected)
This mode must be turned on if EscapeCommFunction(SETXON\XOFF) is used by the application connecting to the Blue Heat/Net port. This allows the Blue Heat/Net to keep the flow control state synchronized with these IOCTLs.
It is best to leave this option unselected if this specific EscapeCommFunction(SETXON\XOFF) is not used, because the extra work needed to maintain the flow state slows communications down.
- **Apply to All Ports** (default is unselected)
This will apply the above two settings to all ports of the same Blue Heat/Net box.

RS-232

This option sets the line interface mode to RS-232. In models supporting both RS-232 and RS-422/485, the default setting is RS-232.

RS-485 Options (on RS-422/485 ports)

This option is checked to access the following options, available on RS-422/485 models of the Blue Heat/Net:

- **Full Duplex** (default)
In this mode TxD & RxD are active all the time. This mode is typically used in point-to-point situations much like RS-232. RTS and CTS can be used along with the data signals.
- **Half Duplex**
In this mode the TxD line driver is only enabled when data is transmitted, and RxD is disabled when data is being transmitted. This mode is typically used in either point-to-point "two wire" connections OR in multi-drop "two wire" bussed connections. CTS and RTS are not usually used with this configuration.
- **Multi-Drop Slave**
In this mode the TxD line driver is only enabled when data is transmitted and RxD is enabled all the time. This mode is typically used in multi-drop "four wire" connections. RTS and CTS are not usually used in this configuration.
- **Line Bias and Termination**
This enables the line and bias termination.

Baud Rate Mapping

In some applications, high or unusual baud rates such as 230400 bps cannot be specified directly. For such situations, two baud rates (110 bps and 300 bps) are provided which can be mapped to different values if necessary.

The image shows a software dialog box titled "Baud Rate Mapping". It contains three main sections:

- A label "Baud Rate Mapping" above a horizontal line.
- An input field labeled "110 Mapped To" containing the text "110".
- An input field labeled "300 Mapped To" containing the text "230400".
- A dropdown menu labeled "COM Port Number:" with "COM4" selected.

Figure 44: Baud Rate Mapping options

By default 300 baud is mapped to 230400 baud. In this case, an actual baud rate of 230400 will be set when 300 baud is specified.

If baud rate mapping is not desired, specify the same baud rate in the edit box beside each of the selections. For example 300 would be set to 300 and 110 would be set to 110.

COM Port Number

The Blue Heat/Net driver supports the ability to change COM port names, also referred to as COM port mapping. Use this combo box to change the COM port number to be used for the current port. For example specifying COM5 would set the COM name for this port to COM5.

Ensure the COM name selected is not already in use or the port may not respond properly.

Scan

- Scan Devices** (default is selected)
 In this mode, the OS will scan devices attached to ports and install them during reboot or when the driver restarts. In some situations, the OS will install a serial mouse device when data is being received at the ports during reboot or restart of the driver. In that case, uncheck so that OS will not install phantom devices.
- Apply to All Ports**
 This will apply the above setting to all ports of the same Blue Heat/Net box.

Defaults Button

The defaults button resets the current settings for all options on the Advanced Settings dialogue box to the default settings (With the exception of the COM Port Number).

Replacing your Blue Heat/Net:

This option is located under the Action menu when the Blue Heat/Net unit is selected. It is used if you need to replace the selected Blue Heat/Net with another Blue Heat/Net. You must have the new unit's MAC address or IP address, as you will be prompted to supply one of these parameters. The **Replace Blue Heat/Net** is helpful if a unit needs to be replaced with an identical one, for whatever reason. (If the new unit's hostname is changed to be exactly the same as the replaced unit, it will not be necessary to follow this procedure. The driver will automatically replace the unit.)

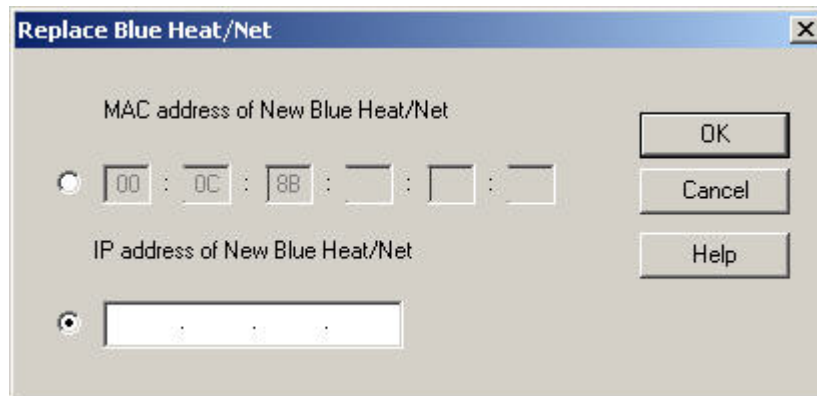

Figure 45: Replace Blue Heat/Net window

Removing your Blue Heat/Net:

Selecting Remove Blue Heat/Net in the Action menu will remove the Blue Heat/Net device you have selected from your system. To remove more than one Blue Heat/Net at a time, select My Blue Heat/Net Places, and either right-click or choose Action from the menu, and select Remove All Blue Heat/Net. This will remove all Blue Heat/Nets located on your system.

Blue Heat/Net Properties:

This provides information about the Blue Heat/Net you have selected. It includes Host name, MAC address, IP Address, Serial No., CDS Version, uClinux Version, Boot Loader Version, and the Number of Ports on your Blue Heat/Net.

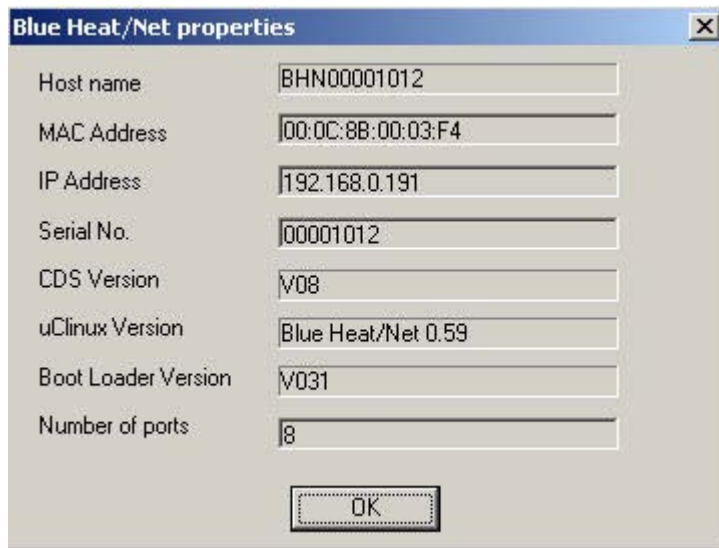

Figure 46: Blue Heat/Net properties

Driver Removal

Located under the Tools menu, choosing Remove Drivers while the Blue Heat/Net unit is selected will remove the drivers for units on your system. A warning box will appear to ensure you wish to continue. Click OK to remove all Blue Heat/Net device drivers.

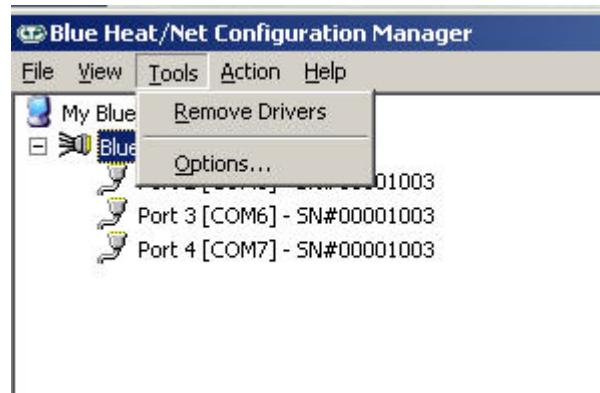

Figure 47: Remove Drivers window

Software Installation for Linux

Installing the Linux host driver

Configure your Blue Heat/Net prior to installing your Linux driver, as outlined in the [Configuration](#) section of this manual. Once you have your Blue Heat/Net configured, connect the Blue Heat/Net to the network and make sure you can communicate with the unit.

If it is connected, but you can't communicate with the Blue Heat/Net, try using the [SCM](#) (Serial Configuration Manager) to reconfigure the network settings.

Set the line modes of each port (232, 485-HD, 485-FD, etc). This step is vital if your Blue Heat/Net is to operate correctly within the Linux Operating System. You can configure the line modes using any of the configuration managers. Reboot your Blue Heat/Net and ping the unit.

The Linux driver is available on the CD that shipped with your Blue Heat/Net. The latest version of the Linux driver is also available for download from the Connect Tech website.

Insert the CD provided with your Blue Heat/Net into the disk drive. Follow the steps below to install the driver.

1. Log in as root.
2. Mount your CD drive (where XX is your CD ROM drive location).
`mount /dev/hdxx/mnt/cdrom`
3. Copy the driver to your home directory.
`cp /mnt/cdrom/bh-net/Linux/*.gz`
4. Change the directory to your home.
`cd`
5. Unzip the given .tar.gz file into a temporary directory.
`tar -xvzf BHN_LHD.tar.gz`
6. Navigate to the temporary directory.
`cd BHN_LHD`
7. Run the install script and follow the on-screen instructions.
`./BHN_LHD-install.sh`

Linux host driver setup using auto discovery

1. Navigate to the install directory.
`cd /usr/cti/BHN-Linux`
2. Create a configuration file.
`cat /proc/bhn/autodiscover > ./bhn.conf`
3. Run blood.
`./blood`
This will attach the driver to /dev nodes according to ./bhn.conf

To test the installation, run a local loopback test between two ports using a standard serial terminal program (like minicom) and a null modem cable.

You should now have a set of Blue Heat/Net ports available as /dev/bhnS*. The file bhn.conf is used to set the serial port mappings. For more information on serial port mapping in Linux, please refer to the Readme.txt located on the Blue Heat/Net CD.

Note: If you purchased a Blue Heat/Net before April 2005, you should update your firmware using Connect Tech's FTP site. This option is available in the [Firmware](#) section in the Web Configuration Manager. Should you have any problems, try updating again and then contact [Connect Tech Technical Support](#).

Firmware Upgrades

If you need to re-install your current firmware, it is located in the firmware directory of the CD you received with your Blue Heat/Net.

Newer firmware versions are available from Connect Tech's website, <http://www.connecttech.com/asp/Support/DownloadZone.asp>. Choose Blue Heat/Net product. Ensure the following parameters are set: `mip`, `sip`, `gip` and `dns_ip` using either the SCM or TCM. To upgrade your Blue Heat/Net firmware, you can use any of the following three methods, depending on your preference.

Upgrade using WCM (Web Configuration Manager)

The Web Configuration Manager is the easiest way to upgrade your firmware. Simply log onto the WCM as described in the [WCM](#) section, and click on the Firmware link on the left menu. This will bring you to the Firmware page. You will have the option to upgrade from the remote CTI website, or to download the upgrade from a local FTP server. If you choose to upgrade via a local FTP server, copy the firmware (*.tar) file to the anonymous directory of a local FTP server. If you do not have a local FTP server, contact your system administrator to set one up.

Upgrade using TCM (Telnet Configuration Manager)

Using the TCM application to upgrade your firmware requires you manually copy the firmware from the CTI website to the anonymous FTP directory of your server. Then Telnet to the Blue Heat/Net unit, log in as TCM and use the update command to complete the upgrade. The upgrade command supports an option to upgrade from Connect Tech's FTP directory.

Upgrade using SCM (Serial Configuration Manager)







The SCM method of upgrading is used when the Blue Heat/Net does not boot properly. You can reinstall your original firmware from the supplied CD, or you can download any newer versions that exist from the CTI website in the [Download Zone](#) or go directly to the FTP site as indicated below.

You will need the use of a TFTP server. (Contact your system administrator to obtain access to a TFTP server). Download the most recent firmware components from the FTP site <ftp.connecttech.com/pub/BHN/>. These files include `BHNuClinux_X.XX.gz`, `BHNloader_VXXX.gz` and `BHNjffs2_X.XX.gz`.

These files contain all of the Blue Heat/Net firmware. Follow the `update` command instructions for the [SCM](#) to update each component.

Appendix

Blue Heat/Net Specifications

Number of ports	2, 4 or 8
Electrical Interface	2 port models: 2 ports RS-232 or 2 ports switchable RS-232/422/485 4 port models: 4 ports RS-232 or 4 ports switchable RS-232/422/485 8 port models: 8 ports RS-232 or 8 ports switchable RS-232/422/485
LAN Interface	10Base-T, 100Base-TX Ethernet (auto-sensing)
Memory	ColdFire CPU features 16MB SDRAM, 2MB Flash, 66 MHz
Control Signals	RS-232: DTR, DSR, RTS, CTS, TxD, RxD, RI*, DCD, GND RS-422/485: TxD+/-, RxD+/-, CTS+/-, RTS+/-, SR *DB-9 version only
Baud Rates	50 bps to 460.8 Kbps (custom baud rates also available)
Protocols	IP, TCP, UDP, ARP, RARP, TFTP, DHCP, BootP, HTTP, Telnet, ICMP, PPP
Configuration	Web browser (HTTP), Telnet console or serial utility
Dimensions	2 port models: Length: 4.55 in/11.56cm Width: 4.50 in/11.68 cm Height: 1.35 in /3.43 cm 4 and 8 port RJ-45: Length: 7.25 in/18.42 cm Width: 5.25 in/13.36 cm Height: 1.35 in/3.43 cm 4 and 8 port DB-9: Length: 9.61 in/24.41 cm Width: 5.25 in/13.34 cm Height: 1.69 in/4.29 cm
Power Requirements	4 and 8 port models: RS-232: External AC/DC power adapter 5V - 6V DC, 1000 mA RS-232/422/485: Universal 5V DC, 2.5 A 2 port models: Multi-mode power adapter, 5V - 30V DC, 500 mA Power over Ethernet (PoE) option: 30 mA@48V DC
Connectors	RS-232: 8 pin RJ-45 connector or DB-9 connector RS-232/422/485: DB-9 connector LAN: RJ-45 connector
Environmental	2 port models: Industrial Temperature range of -40°C to 85°C (-40°F to 185°F) 4 and 8 port models: Temperature range of 0°C to 70°C (32°F to 158°F)
Surge Suppression	EN61000-4-2 ESD EN61000-4-3 EMC EN61000-4-4 EFT
Regulatory Approvals	FCC Class A, Part 15  ICES-003  Industry Canada  EN 55022, EN 55024 
Software Compatibility	Windows 2000/XP, Linux, QNX6 (Contact Connect Tech for the most recent list)   

Products

Model	Ports	Surge	Line Interface	Serial Connector
BN001	4		RS-232	8 circuit RJ-45 Jack
BN002	4	Y	RS-232	8 circuit RJ-45 Jack
BN003	8		RS-232	8 circuit RJ-45 Jack
BN004	8	Y	RS-232	8 circuit RJ-45 Jack
BN005	4		RS-232/422/485	DB-9 Male
BN006	4	Y	RS-232/422/485	DB-9 Male
BN007	8		RS-232/422/485	DB-9 Male
BN008	8	Y	RS-232/422/485	DB-9 Male
BN009	2	Y	RS-232	DB-9 Male
BN010	2	Y	RS-232/422/485	DB-9 Male
BN011	2	Y	RS-232/422/485	DB-9 Male

Options

Part Number	Description
CB004	RJ-45 to DB-25 Female adapter
CB005	RJ-45 to DB-9 Female adapter
CB006	Straight through CAT 5 Ethernet Cable 1.8 m (6 ft). Can be used with CB004 and CB005
MS003	1A 5V unregulated power supply for North America
MS004	1A 5V unregulated power supply for United Kingdom
MS005	1A 5V unregulated power supply for European Union
MS006	1A 5V unregulated power supply for Australia/New Zealand
MS007	3.0A 5V regulated universal power supply with North American line cord
MS008	3.0A 5V regulated universal power supply, no line cord.

Protocol Descriptions

The Blue Heat/Net supports a variety of protocols. The following is a brief explanation of each and how they are implemented.

ARP

Address Resolution Protocol, a method used to find a unit's Ethernet MAC address from its Internet address.

BOOTP

Bootstrap Protocol, a protocol that allows a unit to boot from the network instead of using information stored on the Blue Heat/Net (typically in Flash memory).

DHCP

Dynamic Host Configuration Protocol, a protocol that provides a means to dynamically allocate IP addresses to computers on a local area network. The system administrator assigns a range of IP addresses to DHCP and each client device on the Local Area Network requests an IP address from the DHCP server. The request and grant process uses a lease concept with a controllable time period. The Blue Heat/Net offers this as a configurable option; it can either be turned on or the user can set a fixed IP on the unit.

HTTP

HyperText Transfer Protocol, a standardized Protocol that Web Browsers use to connect to web pages. It is used to provide web based configuration tools on the Blue Heat/Net.

IP

Internet Protocol, a common addressing scheme for modern networks. Used in conjunction with TCP to form TCP/IP (see below)

RARP

Reverse Address Resolution Protocol, a method to find a unit's Internet address from a MAC or Ethernet address.

TCP

Transmission Control Protocol, a lossless protocol, requiring a handshake to insure that data is not lost during transmission. Used in TCP/IP to form the main data transfer pathway between Blue Heat/Net units and the host computer.

Telnet

A terminal-protocol that can be run over TCP/IP to connect to a remote unit. It is one of the methods used to configure the Blue Heat/Net unit.

TFTP

Trivial File Transfer Protocol, a protocol used to download firmware to the Blue Heat/Net.

UDP

User Datagram Protocol, a protocol used when handshake is not critical. It is used by TFTP (see above) and for auto discovery of the units.

Pinouts

RS-232 and RS-485

RS-232			RS-485	
Signal	DB-9	RJ-45	Signal	DB-9
DCD	1	3	RXD+	1
RXD	2	4	RXD-	2
TXD	3	5	TXD+	3
DTR	4	7	TXD-	4
GND	5	6	GND	5
DSR	6	2	CTS-	6
RTS	7	1	RTS+	7
CTS	8	8	CTS+	8
RI	9	N/A	RTS-	9

Figure 48: RS-232 and RS-485 pinouts

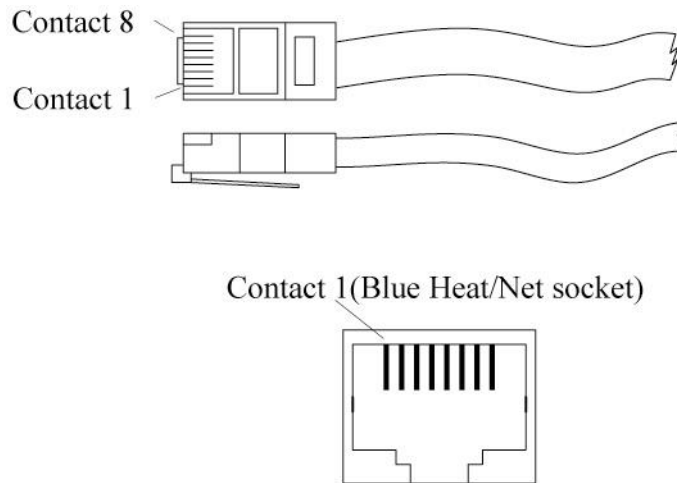

Cabling Examples:

Typical RS-232 null modem connection:

- This is used to connect to DTE type devices.
- The Blue Heat/Net is a DTE type device.
- Used when Hardware RTS->CTS flow control is required.
- This cable is also called a cross over cable and is commonly available at any Electronics retailer/distributor.

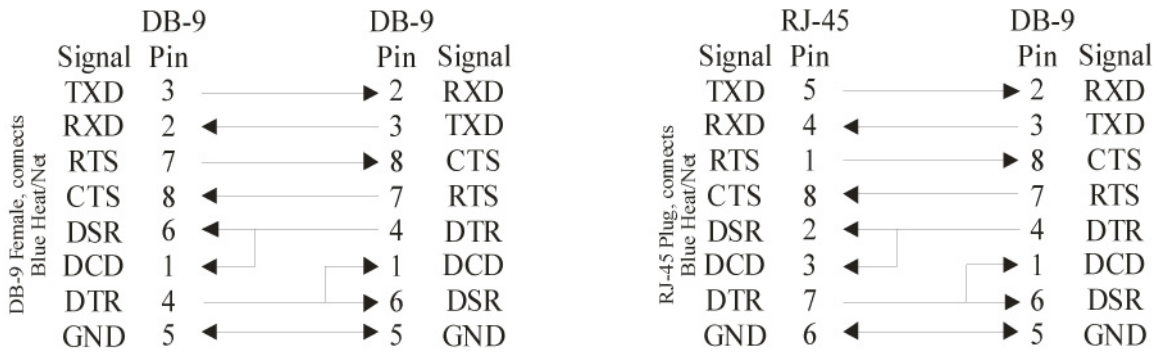

Basic “3 wire” RS-232 null modem connection:

This is used to connect to DTE type devices.
 The Blue Heat/Net is a DTE type device.
 Used when Hardware RTS->CTS flow control is **not** required.
 This cable is also called a cross over cable.

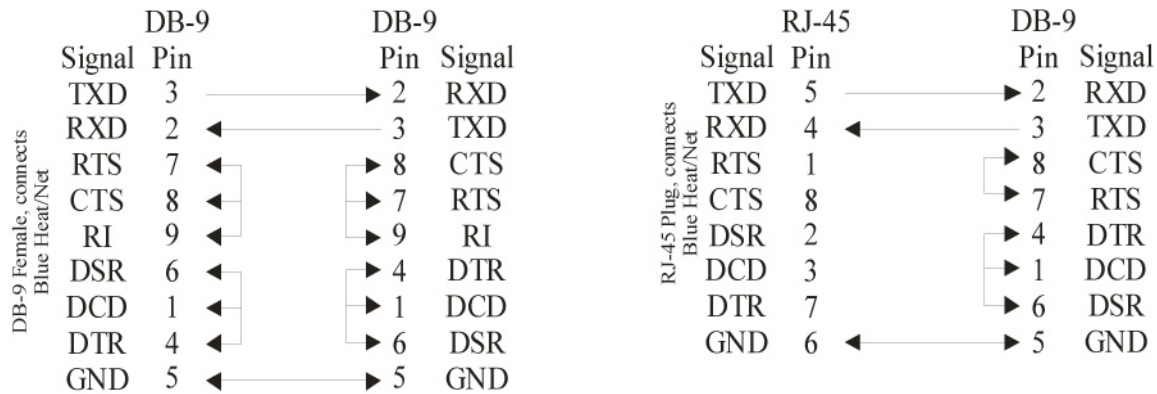

Connecting to DCE type devices:

DCE type devices do not require a Null Modem cable, they require a straight through cable.
 Straight through cables, both DB-9 to DB-9 and DB-9 to DB-25 are commonly available.

The following is an example of a DB-9 Female cable to a DB-25 Male cable to connect to a modem.

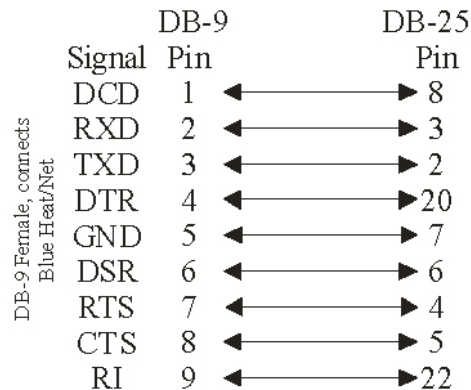

Loopback Connectors:

Loopback connectors are useful for performing diagnostics. The following are the recommended pinouts for creating loopback connectors for Blue Heat/Net products.



Figure 49: Loopback connectors, DB-9 and RJ-45

DB-9: For making DB-9 Female loopback connectors we recommend using solder cup DB-9 connectors and 28 AWG solid core wire.

RJ-45: For making RJ-45 loopback connectors, we recommend using 8 pin RJ-45 connectors and about 2 inches of CAT 5 cable. You will have to crimp the wires from the CAT 5 cable into the RJ-45 plug, then strip and solder the wires to match the above loopback pinout.

RS-422/485 Examples:

RS-422/485 Wiring Tips:

RS-422/485 wiring must always use twisted pair cabling.

For applications which require long cable lengths (100M) and higher baud rates (115.2kbps) we recommend using “low capacitance computer cabling”, or cabling specifically for RS-422/485 applications.

For maximum reliability in noisy environments we recommend using shielded cabling. The drain wire of the shield should be connected at one end of the cable only. We recommend the shield at the RS-485 device end.

4-wire (full duplex, “RS-422 mode”) Wiring hardware flow control

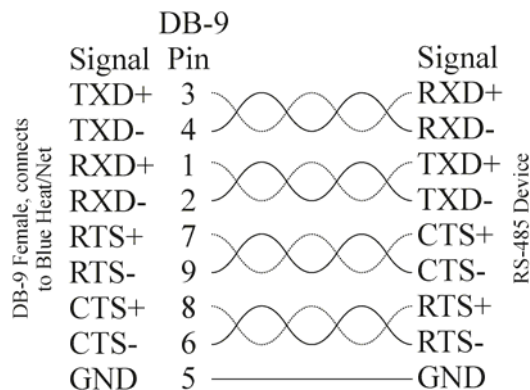

Four-wire (full duplex, "RS-422 mode") Wiring without hardware flow control.

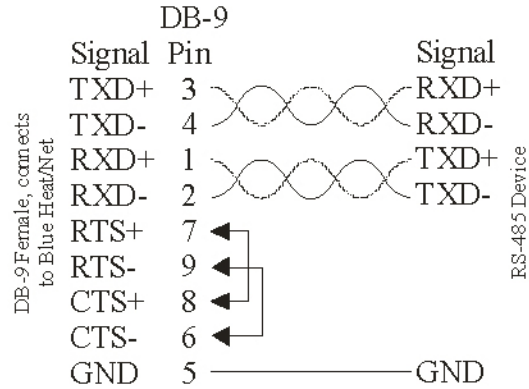

Four-wire (full duplex multi-drop, "RS-485 mode")

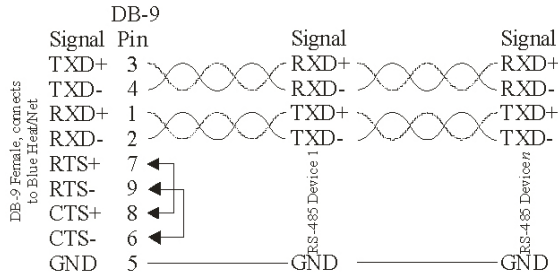

Note: The flow control signals, RTS and CTS should be connected as per diagram when unused to prevent loss of performance on your Blue Heat/Net

Two-wire (1/2 duplex, "RS-485 mode") Wiring

One device connected to Blue Heat/Net

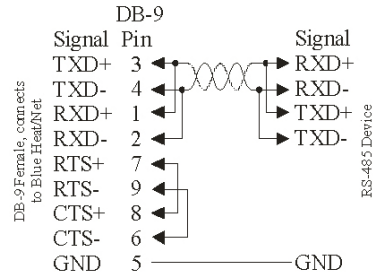

Two devices connected to Blue Heat/Net

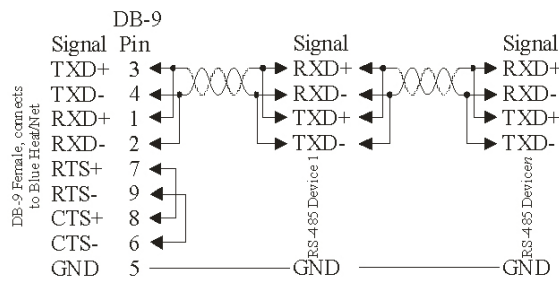

RS-485 Multi-drop Topology, Two-Wire and Four-Wire

When wiring multi-drop RS-485 networks, it is necessary to wire the devices in a "Daisy Chain", they must not be wired with a "Star" topology, see diagram.

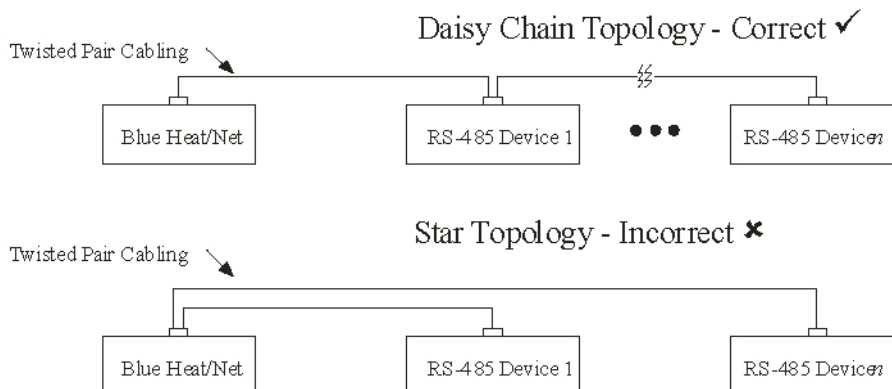

Default Settings

Network Settings

Blue Heat/Net IP address	192.168.42.1
Server IP address	0.0.0.0 (used for firmware downloads)
Gateway IP address	0.0.0.0
Subnet Mask	255.255.255.0
Broadcast IP address	255.255.255.255 (used by the bootp process)
Domain Name Server IP address:	0.0.0.0 (used for firmware downloads)
Domain Name	blueheat.net
Host Name	BHNsssssss (where sssssss is the BHN serial number)
TCP Port	49152 (0xC000)
DNS IP	0.0.0.0

Boot Settings

Default enabled:
 Boot from Flash

Default disabled:
 use BOOTP
 use TFTP

Delay: 30 (seconds)

SCM Operation Settings

Password: password

Password Prompting: enabled

Loader Filename: BHNloader_vvv.gz
 (where vvv is the version number of the Loader, current at the time the unit was manufactured).

Line Setting: See [Getting Access to SCM](#) section.

CDS (Configuration Data Space)

CDS Storage

This area stores the following data:

- CDS Version number
- Blue Heat/Net information
 - Serial Number
 - Software version numbers
- Network Information
 - MAC Address
 - Blue Heat/Net IP address
 - Server IP address
 - Gateway IP address
 - Subnet Mask IP address
 - Broadcast IP address
 - Domain Name Server IP address
 - Domain Name
 - Host Name
 - TCP Port number
 - DHCP setting
- Boot Information

- Boot Mode
- Boot Filename
- SCM Parameters
 - Port to scan
 - Scan Timeout
 - Scan Prompt setting
 - Password
 - Password changed
 - Loader filename
- System Parameters
 - Password
 - Password changed
 - Inactivity Timeout
- Serial Port Information
 - Number of Ports
 - UART type
- Port Settings
 - Line mode
 - Baud rate
 - Data bits
 - Parity setting
 - Stop bits
 - Software flow control settings
 - Xoff, Xon characters
 - Hardware flow control settings
 - Local loopback
 - Special Error/Event handling modes and Character settings
 - Default personality

Common Configuration Setups

Static IP Setup

In some networking environments it is best to have the IP address set to a fixed value. The advantage is that since it is fixed, connecting to it can be a lot simpler.

Static IP is often the best choice if you are trying to connect via WAN or through a Firewall. It can be difficult to resolve the Blue Heat/Net's IP address if you use DHCP in this instance.

The default configuration is a static IP of 192.168.42.1. In most cases this will not be the address you want to use in your network. You can change it using three different methods:

Serial Configuration Manager (SCM)

A direct serial connection to one of the serial ports on the Blue Heat/Net.

Telnet Configuration Manager. (TCM)

A Telnet connection to the Blue Heat/Net

Web Configuration Manager (WCM)

Using a web browser like Internet Explorer to connect to the unit.

Refer to the manual sections for specific details on using the SCM, TCM and WCM.

Example:

You want to configure a static IP on a Blue Heat/Net of 198.182.196.15. The network's server is at 198.182.196.1 and the gateway is 198.182.196.2. The subnet mask is 255.255.255.0.

Using SCM/TCM

Log onto the Blue Heat/Net. The default login for the TCM is **root**. (There is no login necessary if using SCM.) The default password for both TCM and the SCM is **password**.

Enter **net net=198.182.196.0**. This will set 198.182.196.0 to the server, gateway and the unit's IP in one step.

Enter **net my_ip=15**. This will set the unit's IP to 198.182.196.15.

Enter **net server_ip=1**. This will set the server IP to 198.182.196.1.

Enter **net gateway_ip=2**. This will set the gateway IP to 198.182.196.2.

Enter **net subnetmask=255.255.255.0**. This will set the subnet mask.

Enter **net dns_ip=3**. This will set the DNS IP to 198.182.196.3

Enter **net dhcp=no**. This will turn off DHCP on the unit.

Enter **save**. This will save the configuration set above to flash memory.

Enter **exit**. The unit will reboot using the new settings.

Using WCM

Connect to the Blue Heat/Net using a web browser by entering the current IP of the unit in the address.

Log on by supplying the username and password. The default login is **wcm** and the default password is **password**.

Select the **Blue Heat/Net Settings** page and fill in the server IP, Blue Heat/Net IP, Gateway IP, DNS IP and subnet mask as defined above.

Ensure the Use DHCP option is set to **no**

Click on the **Save to Flash** button to store the changes.

DHCP Setup

In many modern networks IP numbers are not static but are automatically assigned by a DHCP server and can change over time or on each power up.

DHCP must be enabled on the Blue Heat/Net because it is shipped to use a default static IP (192.168.42.1)

Using SCM/TCM

Log onto the Blue Heat/Net. (If using the SCM, no login is required. For the TCM, the default login is **root**.) The default password for both SCM and TCM is **password**.

Enter **net dhcp=yes**. This will turn on DHCP on the unit.

Enter **net dns_ip=3**. This will set the DNS IP to 198.182.196.3

Enter **save**. This will save the configuration we just set to flash memory.

Enter **exit**. The unit will reboot using the new settings.

DIN Rail Mounting Option:

The two-port Blue Heat/Net and DB-9 models of the four and eight port Blue Heat/Net include the option for DIN rail mounting.

The Blue Heat/Net 2 requires two DIN rail clips (part number MS010) that attach to the body of the device.

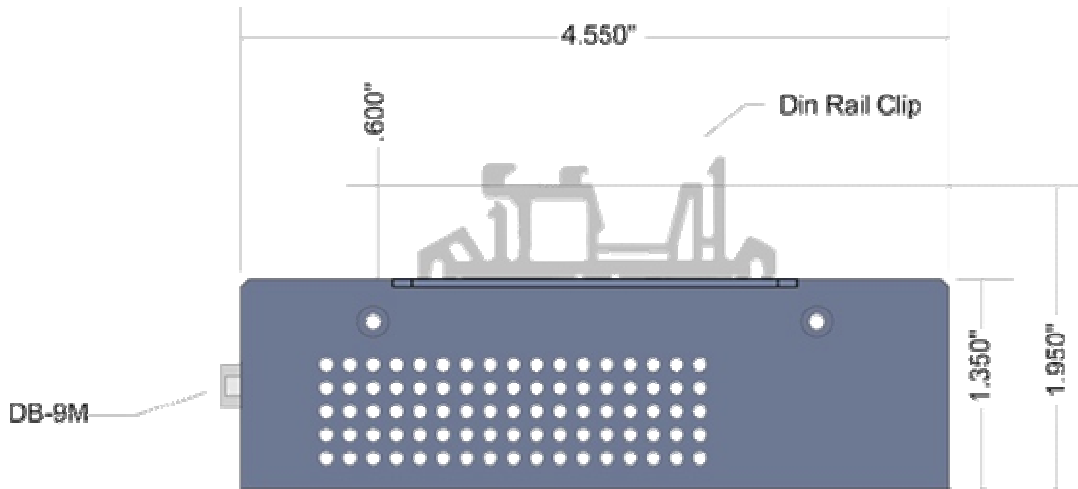
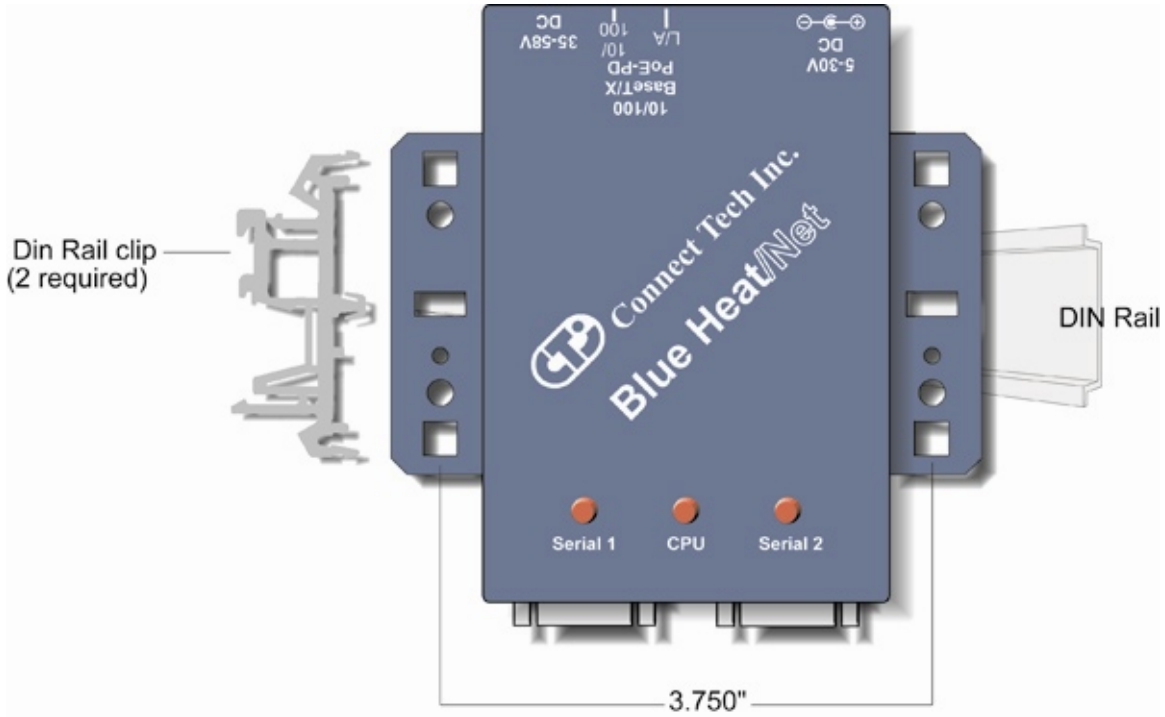

Figure 50: DIN Rail mount option for Blue Heat/Net 2

Four and eight-port DB-9 models can be DIN rail mounted with the addition of a DIN rail bracket, ordered separately as part number MS009. This part number includes the clips.

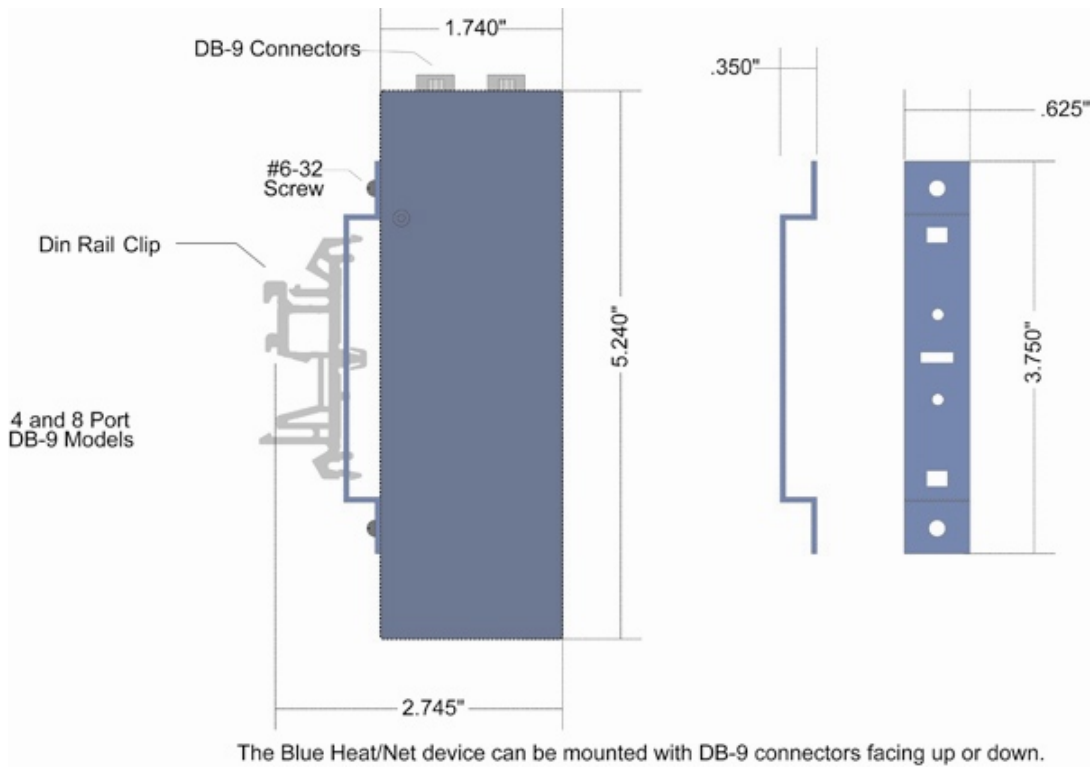
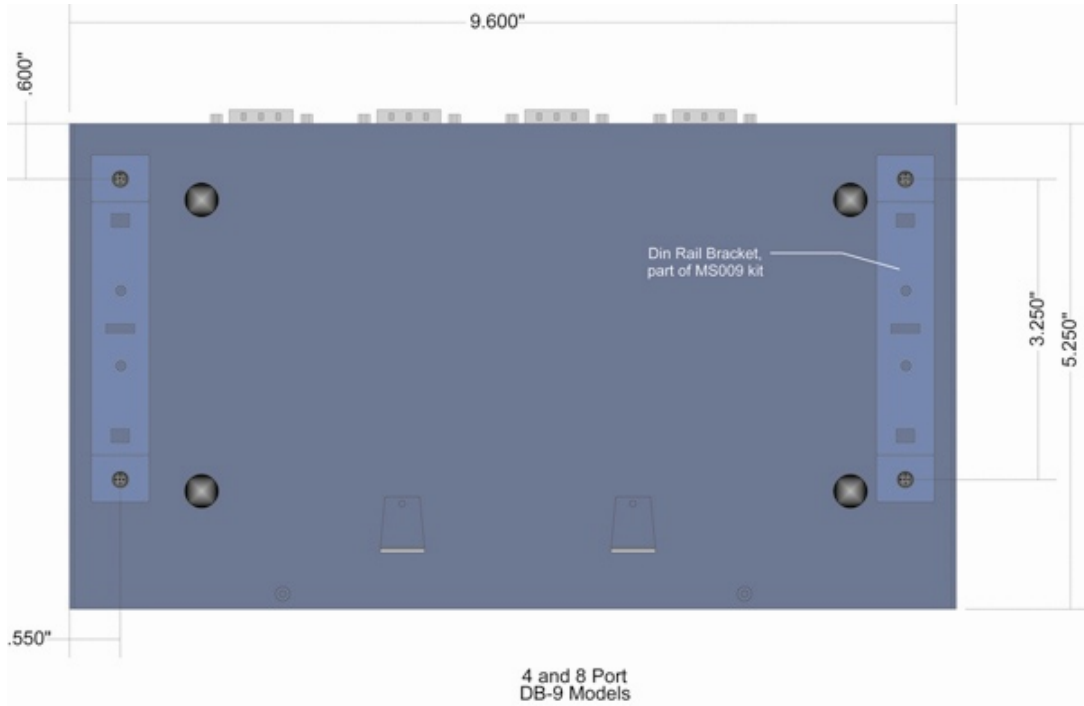

Figure 51: DIN rail mount option for four and eight port DB-9 models

How the Blue Heat/Net Boots Up

Each time the Blue Heat/Net is powered-up or rebooted with an appropriate command, a certain sequence of software execution occurs.

The **Booter** runs from Flash memory first. Its job is to perform the following:

Setup the embedded processor

Validate at least one of the redundant **Loaders** (via a CRC check).

Load a validated **Loader** into RAM memory.

Run the **Loader**.

If the **Booter** discovers that both **Loader** programs are defective (erased or faulty CRC calculation), an error code is displayed on the LEDs of the Blue Heat/Net.

The **Loader** runs from RAM memory. Its job is to perform the following:

- Update any required CDS items.
- Determine if the SCM application will be entered. This is accomplished by scanning the designated serial ports, for a period of time, to determine if a correct password is entered. If the password is found the SCM application will be entered. (see the [SCM/TCM, cfg](#) command for details of these settings).
- Locate, load and run an Operating System (uClinix). (As shown in the following boot-up flow chart).
- Run the main Operating System (uClinix).
- Operating System launches port personality default `ctid`

Flowchart of Special Operations Mode using the reset button

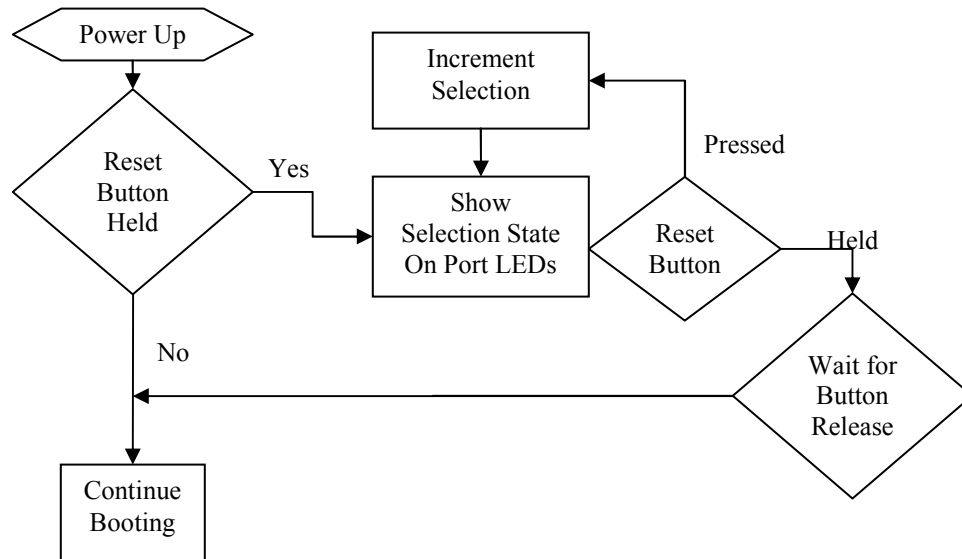

Figure 53: Bootup sequence via Reset Button

Asynchronous communications Tutorial

The Blue Heat/Net features four or eight asynchronous serial communication ports. Asynchronous communications is a simple, cost effective means of terminal serial communication. For this reason, it is widely used for communications on personal computers, bar codes readers, printers, terminals and much more.

In asynchronous serial communication, the electrical interface is held in the idle position between characters, also referred to as “mark”. A change in signal level (known as space level) indicates the start of transmission of a character. The receiver recognizes this change as a “start bit”. Once the start bit has been sent, the transmitter sends the actual data bits. In typical asynchronous communications there may be 5, 6, 7, or 8 data bits, depending on the application. Both the receiver and the transmitter must be set to the same number of data bits, baud rate and stop bits. Stop bits can be 1, 1.5, or 2 bit periods in length. When the transmitter has sent all the data bits, it sends a stop bit. This stop bit signals to the receiver that the data has finished transmission. The stop bit is the same state as the idle or mark state.

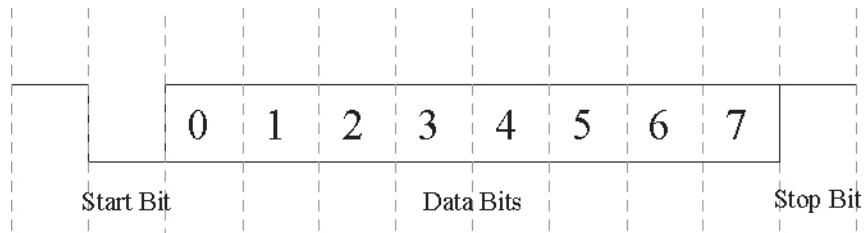

Figure 54: Typical Asynchronous Data frame

Serial Line Interface Tutorial

RS-232 Line Interface:

RS-232 is the simplest, least expensive line interface standard. It is also referred to as EIA232 and TIA/EIA-232. The RS-232 specification signals levels of +3V to +15V for a logic 0 or Space, and -3V to -15V for a logic 1 or Mark. The Blue Heat/Net has RS-232 signal levels with a typical range of +/- 8 Volts. The maximum cable length you can use with RS-232 is dependant on a number of factors including:

Baud rate

The faster the baud rate, the shorter the cable length must be.

Cable quality

Quality refers to the capacitance of the cable. A higher capacitance (usually specified as pF or pico Farads per foot) dictates a lower baud rate, and a shorter maximum length. Low capacitance computer cables for RS-232 applications are available from all wire and cable suppliers.

You can usually operate with cable lengths of up to 100 feet (30 m) at baud rates up to 115.2 Kbps using low capacitance cable. For higher baud rates such as 230.4 Kbps and up, we recommend keeping the cable lengths to within 25 feet (7.6 m).

The TIA/EIA232 specification specifies two connectors: the DB-25 and the DB-9. Each of these connectors has a standardized pinout. Many serial communication products offer RJ-45 connectors, including the Blue Heat/Net family. Note that there is no standard pinout for RS-232 on an RJ-45 connector. The following table specifies Connect Tech's RJ-45 pinout.

RS-232 signals:

DB-9 Pin (Standard)	RJ-45 Pin*	Signal	Description
1	3	DCD	Data Carrier Detect
2	4	RX	Receive Data
3	5	TX	Transmit Data
4	7	DTR	Data Terminal Ready
5	6	GND	Signal Ground
6	2	DSR	Data Set Ready
7	1	RTS	Request to Send
8	8	CTS	Clear to Send
9	N/A	RI	Ring Indicator

*Connect Tech Pinout.

Figure 55: RS-232 signals

RS-485 Line Interface:

RS-485, or TIA/EIA485, is a differential line interface standard capable of high baud rates over long cables. RS-485 is fully compatible with RS-422; which is considered a subset of RS-485. The use of differential transmitters and receivers ensures RS-485 communications are reliable and robust. This means two wires are used to transmit or receive a signal. One wire carries the true or non-inverted signal; the other wire carries the inverted signal. The non-inverted signal is

labelled with a (+) and the inverted is labelled with a (-). The RS-485 specification refers to the (+) as "TXB" and the (-) as "TXA".

Any noise injected into the wires is cancelled at the receiver, leaving only the original, undistorted data signal. Twisted pair cables are always used in RS-485, this ensures that the communications are robust and as error free as possible. RS-485 signal levels are between 0 and 5 Volts, the differential voltage can be as little as 200mV.

RS-485 can operate in three different modes: a 4-wire full duplex interface, 4-wire multi-drop full duplex interface and a 2-wire half duplex interface. A full duplex (bi-directional) RS-485 communications interface requires at least four wires, two for transmit and two for receive. A half duplex interface only requires two wires, this provides a cost effective cabling solution.

Multi-drop is a great feature of RS-485. Multiple RS-485 devices can be bussed together in a daisy chain type fashion to create a network. Up to 32 devices may be connected together on the same network. In multi-drop networks, one of the devices (usually the computer) is designated as the master, and all the other devices are designated as slaves. All communication is initiated by the master. The master and slave designations are established by your communications application.

Basic 4-wire, full duplex RS-485 communications:

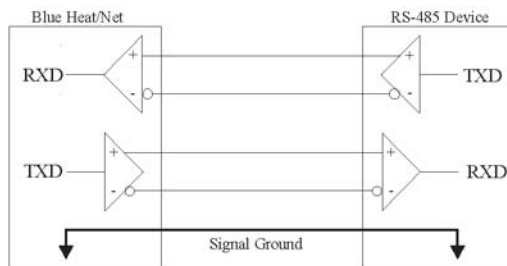

In a 4-wire RS-485 network, two devices are connected together, for example your Blue Heat/Net RS-485 port and an RS-485 device.

Multi-drop 4-wire, full duplex RS-485 communications:

In a multi-drop 4-wire RS-485 network, 2 to 32 devices are connected together. Note that each RS-485 receiver counts as a device or "load". In this multi-drop mode of communication, a master slave protocol must be enforced, that is, all communication is initiated by the master, in this case a Blue Heat/Net. The communication is "full duplex", meaning that receive and transmit traffic occur on different pairs of wires. The Blue Heat/Net can receive and transmit data from/to a device at the same time.

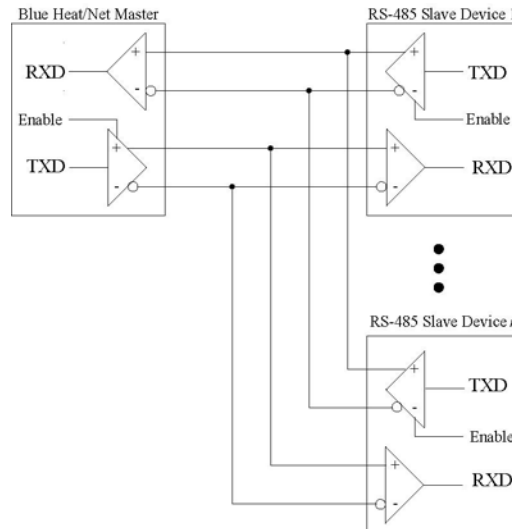
**Basic 2 wire, half duplex multi-drop connection:**

In a 2-wire RS-485 network, 2 to 32 devices are connected together. Note that each RS-485 receiver counts as a device or "load". In this multi-drop mode of communication a master slave protocol must be enforced, that is, all communication is initiated by the master, in this case a Blue Heat/Net. The communication is "half duplex", meaning that receive and transmit traffic occur on the same wire. The Blue Heat/Net and devices can not receive data and transmit data at the same time.

Note that the Receiver +/- and the Transmitter +/- signals are connected together. This is performed at the DB-9 connectors. All communication between devices occurs over a single pair of wires; this can lower the cost of wiring your RS-485 network.

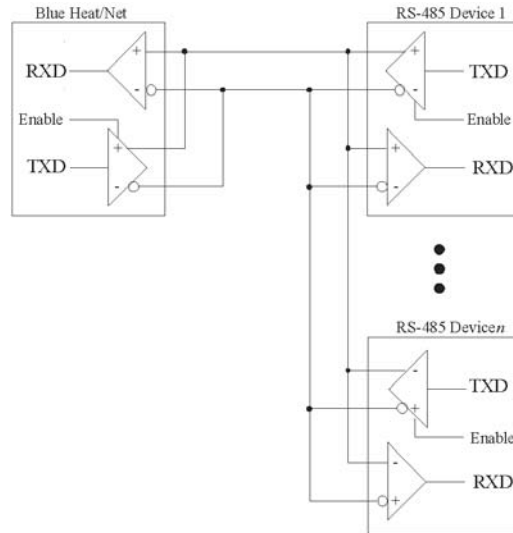

Bus contention on RS-485 multi-drop networks:

Bus contention occurs when two or more devices enabled on a bus attempt to run the bus to opposite logic values. From the diagram above, we can see that there are multiple RS-485 transmitters (TXD) on the bus. To avoid the bus contention problem, the RS-485 transmitter features a tri-state, or high impedance mode controlled by an input pin (enable). Software and hardware in the Blue Heat/Net and the RS-485 devices will always place its transmitter into the high impedance mode when not transmitting. This feature is managed by the Blue Heat/Net and is fully transparent to your application.

For example, in a multi-drop network, the RS-485 transmitter is enabled prior to the master initiating transmission. When transmission is complete, the transmitter is placed in high impedance mode. Each slave will receive that transmission from the master. (A protocol must be in place to address, or select, the desired slave device, but that discussion is beyond the intentions of this tutorial, and is entirely application dependent). When the slave device has received the data, it will respond by enabling its transmitter and transmitting data onto the bus, then placing its transmitter into high impedance mode, just as the master did.

Bias and Termination Resistors in RS-485 networks:

Termination Resistors in RS-485 networks:

RS-485 networks often benefit from the installation of termination resistors. Termination is rarely required for lower baud rates, for example 9600 baud or less. However, RS-485 networks are *transmission lines*, and can suffer from the electrical effects of ringing, or undershoot and overshoot, all of which can cause data errors, especially at higher baud rates, like 115.2 Kbps. Termination resistors should always be installed at the extreme ends of the network, as close to the RS-485 transceiver circuits as possible, as outlined in the diagram below.

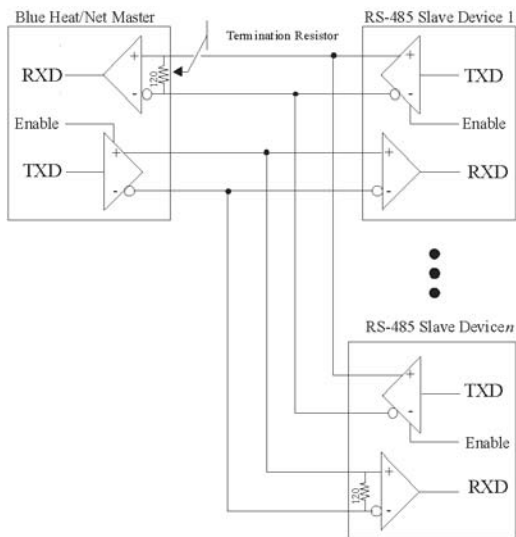

Tips:

RS-485 networks using low baud rates, 9600 baud or less, will not require a termination resistor, unless the cable length is very long.

Usually the addition of a termination resistor at the receiver will be adequate.

If DB-9 connectors are used, the termination resistor can be soldered into the solder cups along with the wires.

Termination resistors should be 120 ohms in value.

Never install more than two termination resistors in a RS-485 network.

Bias Resistors in RS-485 networks:

In multi-drop RS-485 networks, the transmitters are always placed in the high impedance mode when there is no transmit activity. In this mode, the voltage at the RS-485 receivers tends to float to 0 Volts which will not maintain a stable value. In addition, the high impedance of RS-485 receivers makes them susceptible to electrical noise. This can cause the reception of garbage characters and framing errors resulting in problems for your application software.

To avoid this problem, the RS-485 network or bus is held in the inactive or stop bit state using bias resistors. You should **always** have bias resistors installed when you are using a multi-drop network, as outlined in the diagram below:

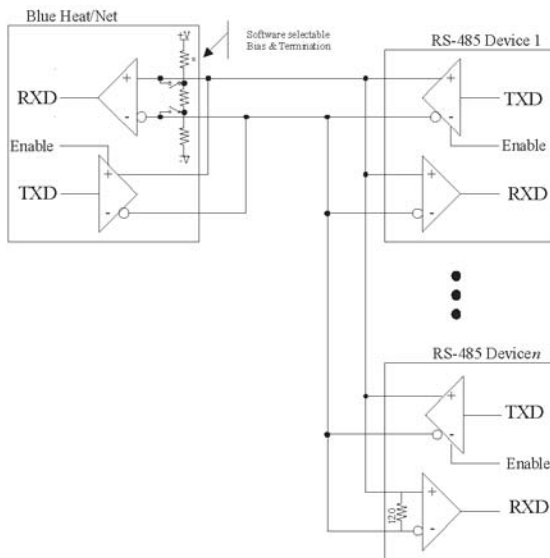

Tip:

In multi-drop and half duplex (2-wire) RS-485 networks, the Bias and Termination network should always be installed.

How to implement Bias and Termination Resistors

The Blue Heat/Net is equipped with unique, software selectable bias and termination resistors on RS-485 models. The user can select the Bias and Termination Option using the [TCM](#), the [SCM](#) or the [WCM](#) Blue Heat/Net configuration tools. These settings will be stored in the Flash memory on the Blue Heat/Net. The setting is immediately applied when the setting is changed and automatically applied after a reset/reboot.

Note that the Bias and Termination network is one network; you can not apply only bias or only termination. Both are applied at the same time.